

*Barbados Mini*  
Art. Nr. 4415040  
1/8

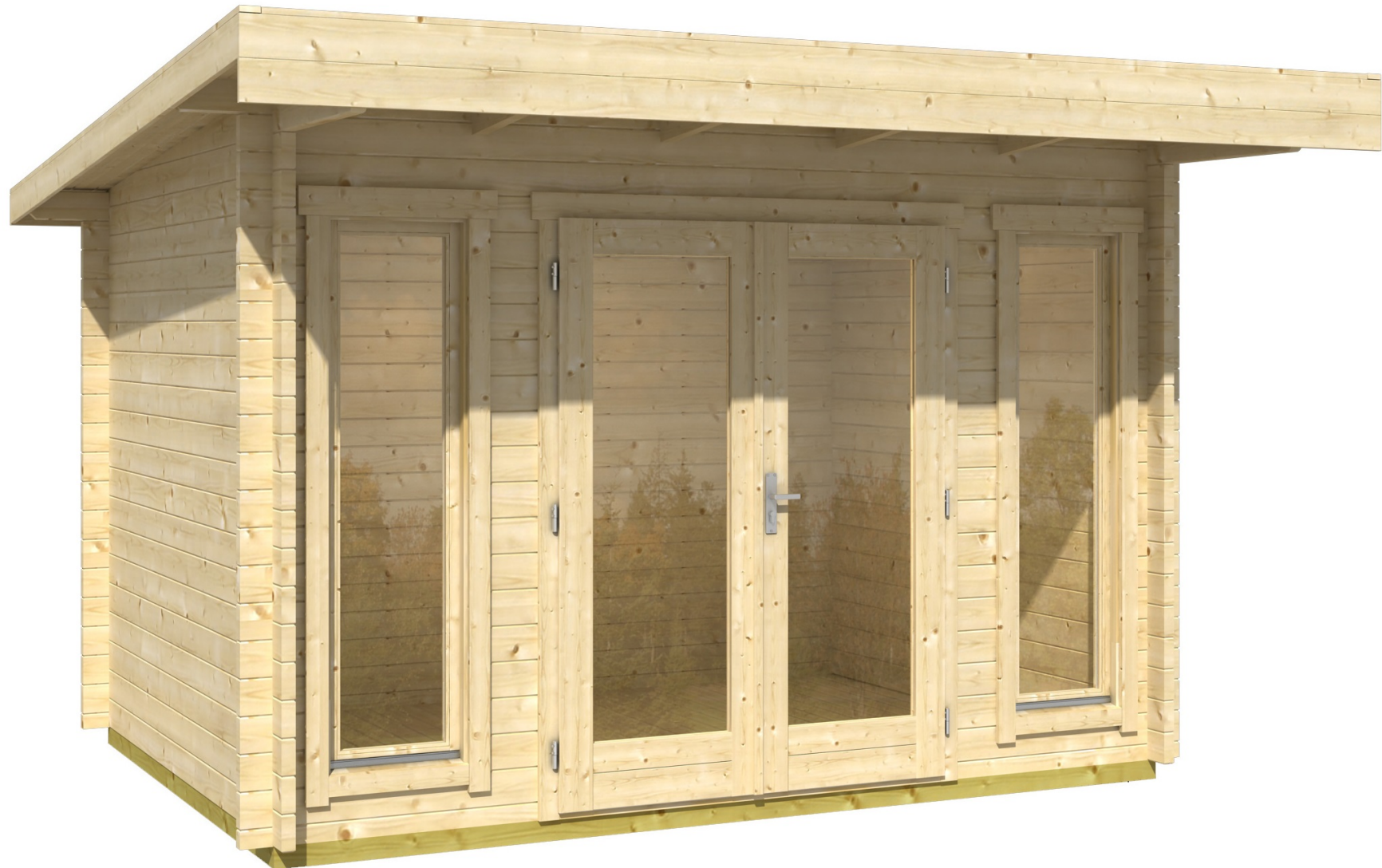

8.06.2017

Art.Nr. 4415040  
GROUNDPLAN - GRUNDPLAN - PLAN DE MASSE

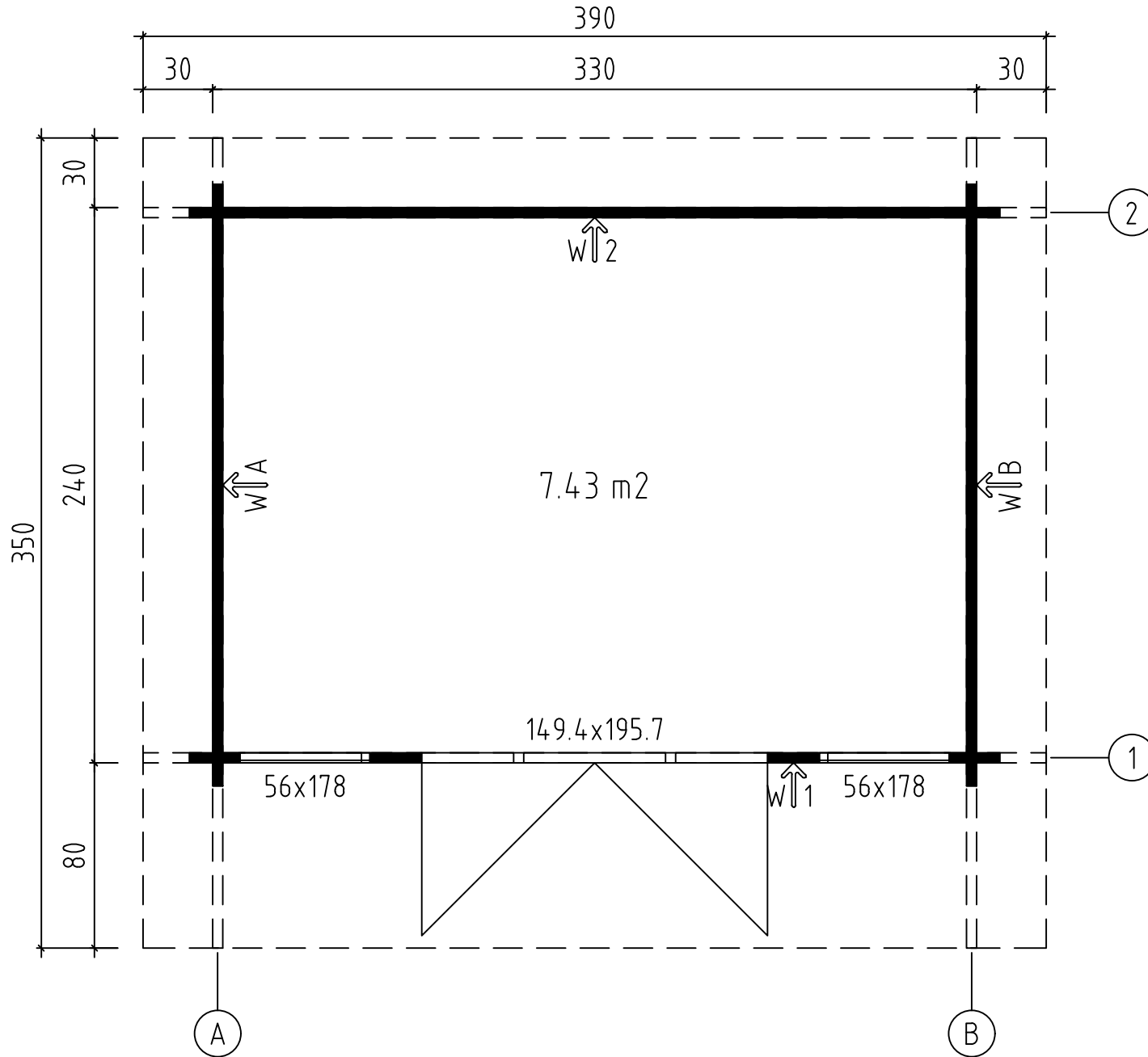

FOUNDATION - FUNDAMENT - FONDATION

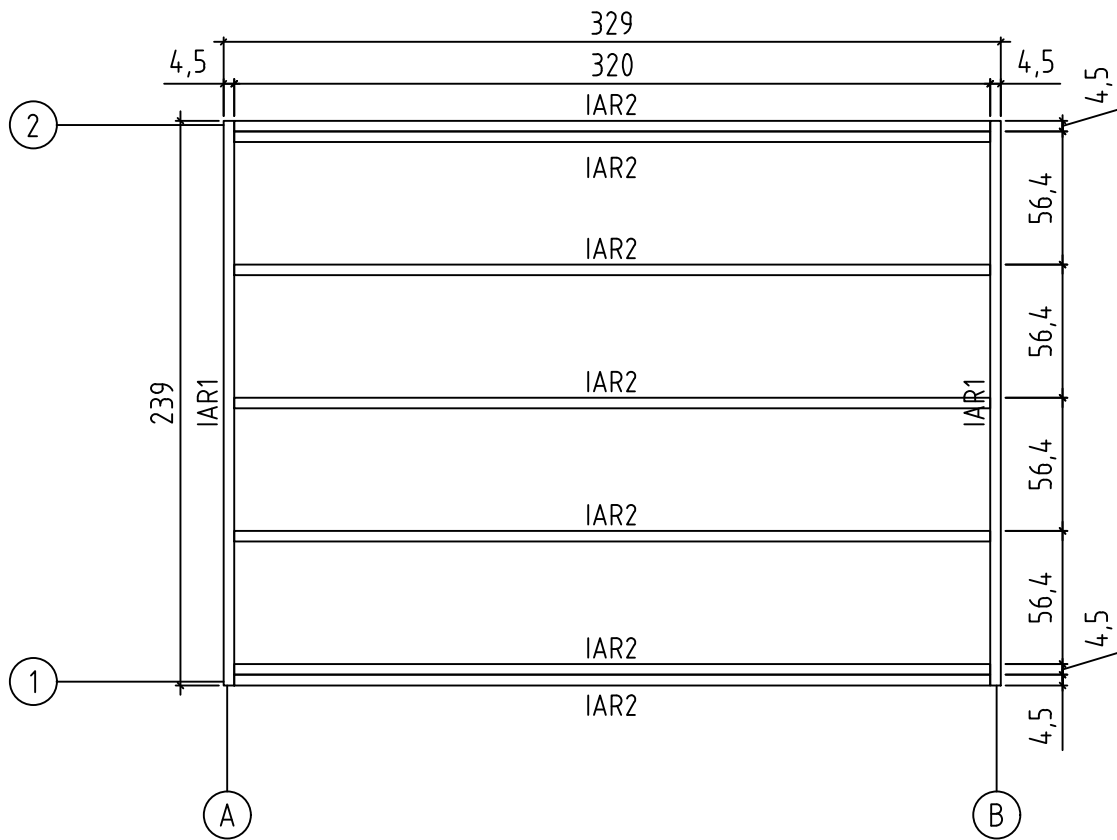

FLOOR BOARDS - FUSSBODENBRETTER - PLAN POSE PLANCHER

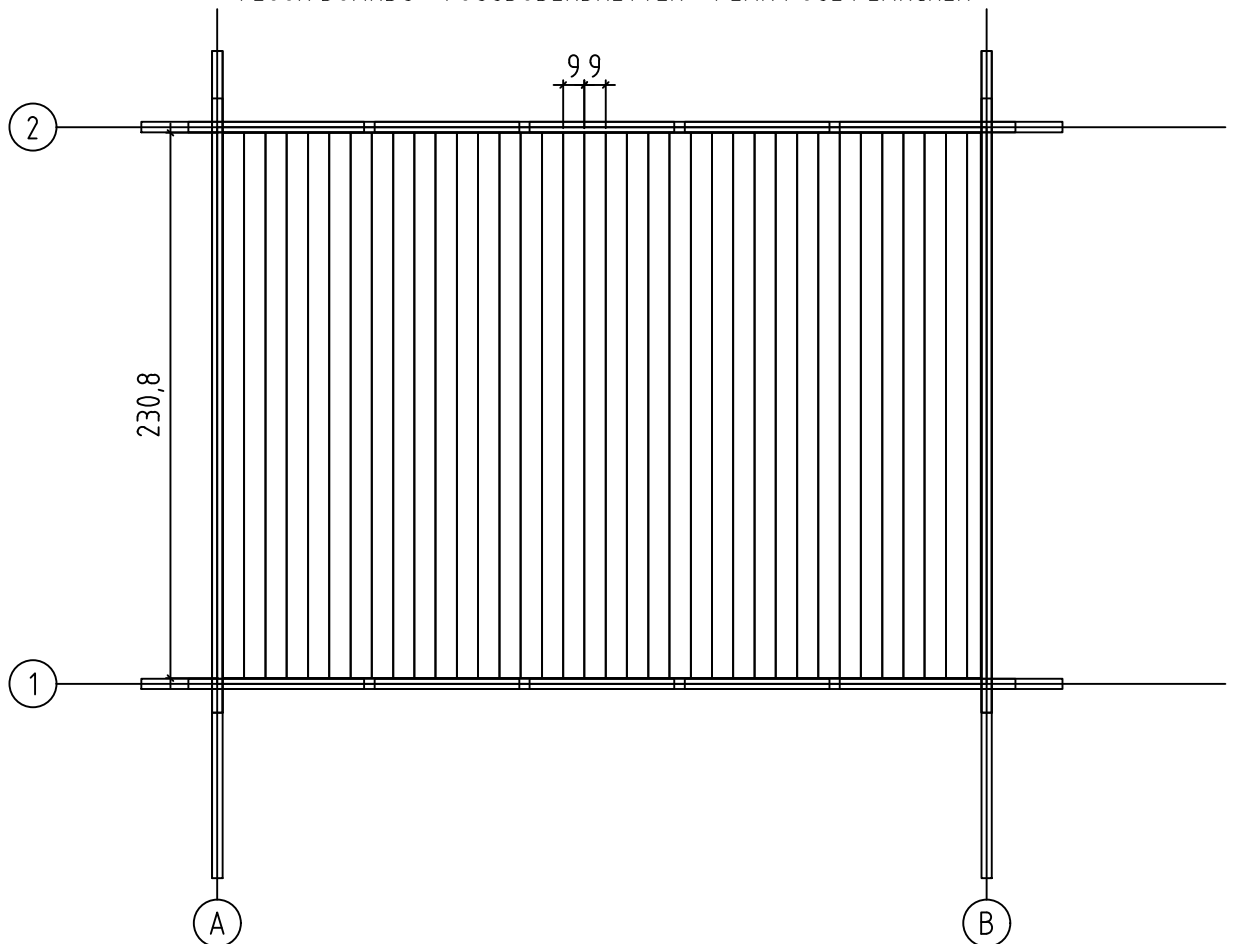

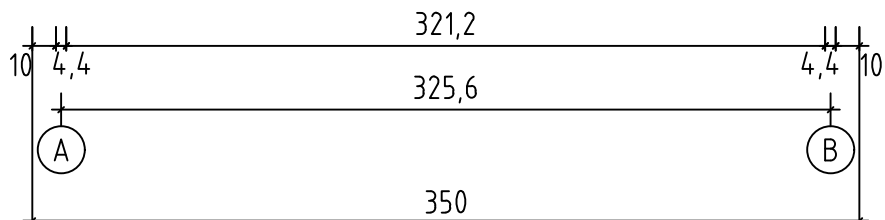
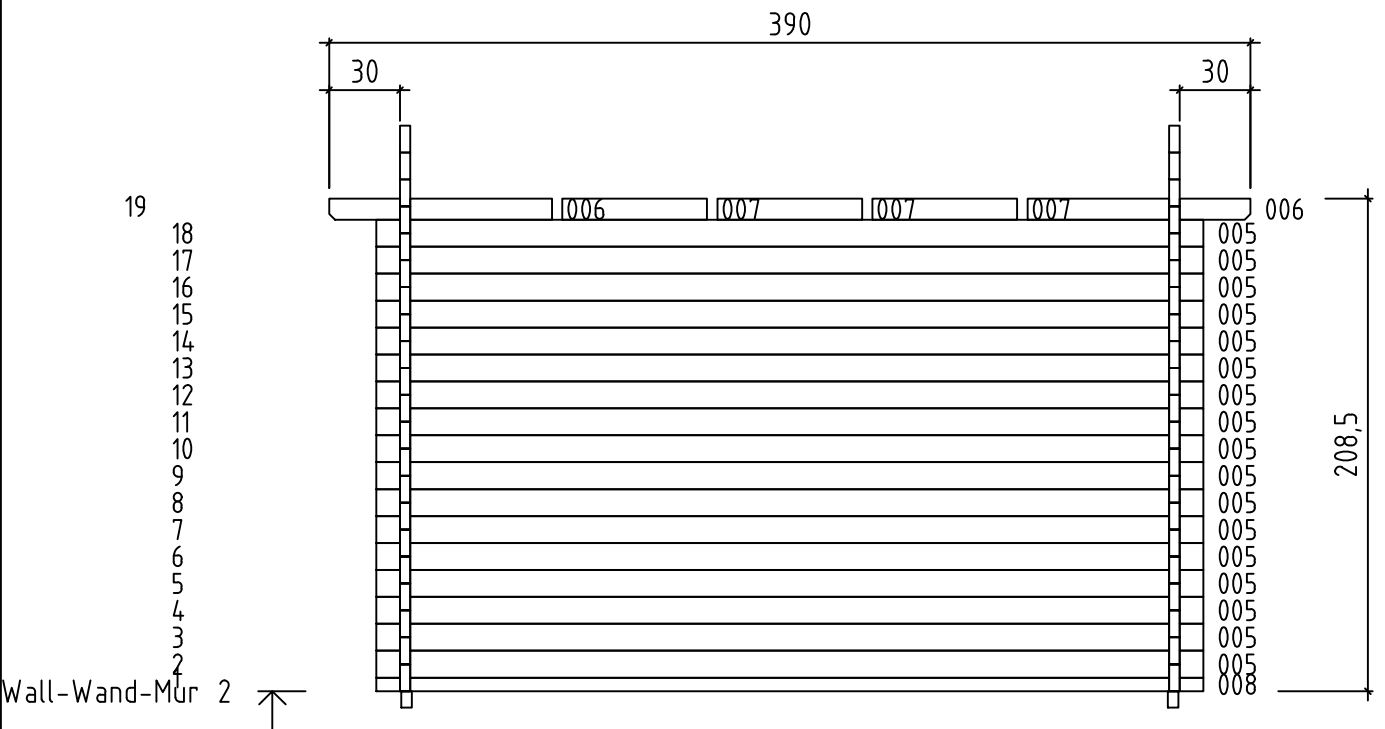
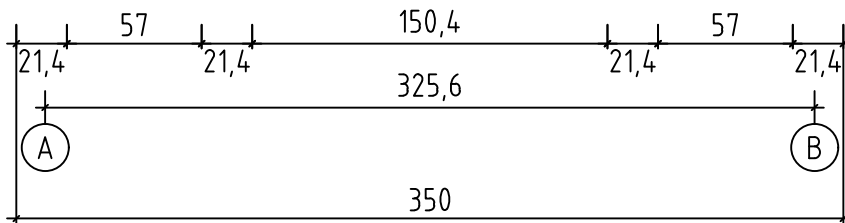
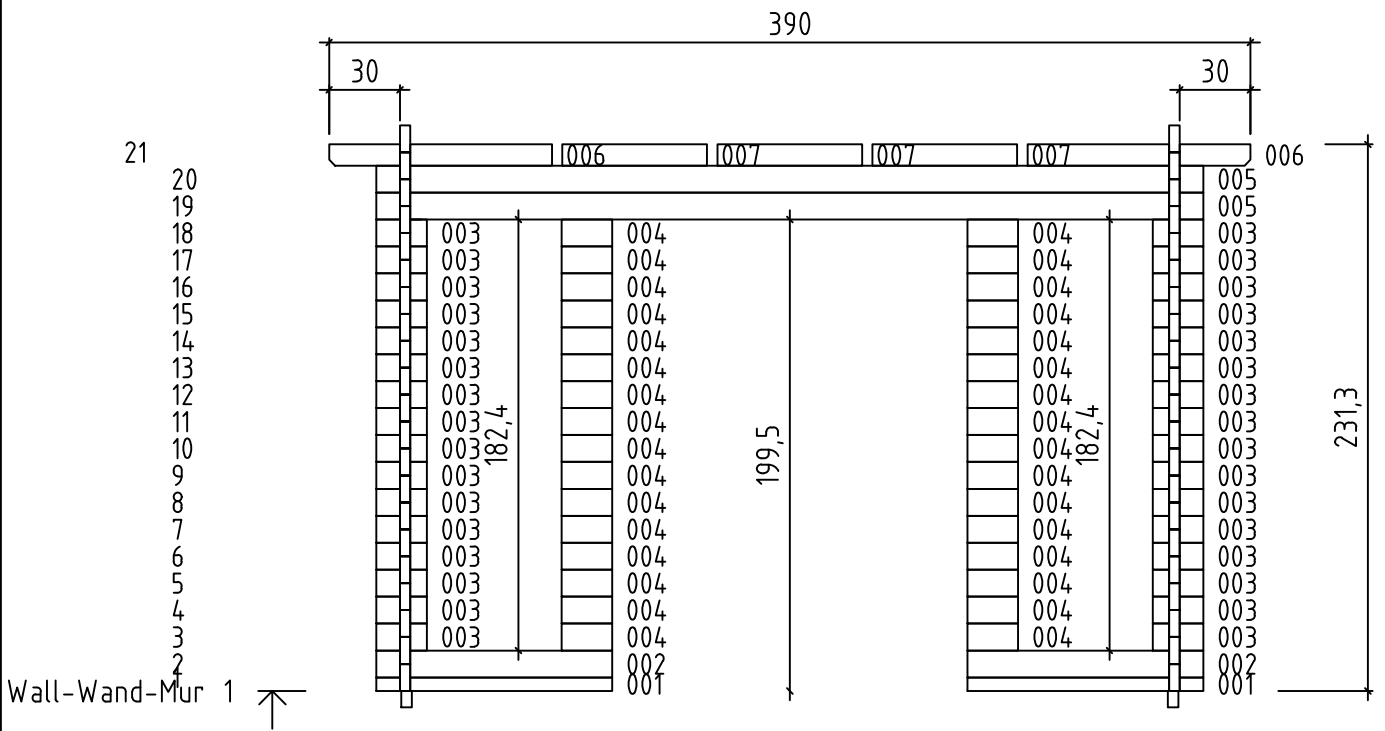

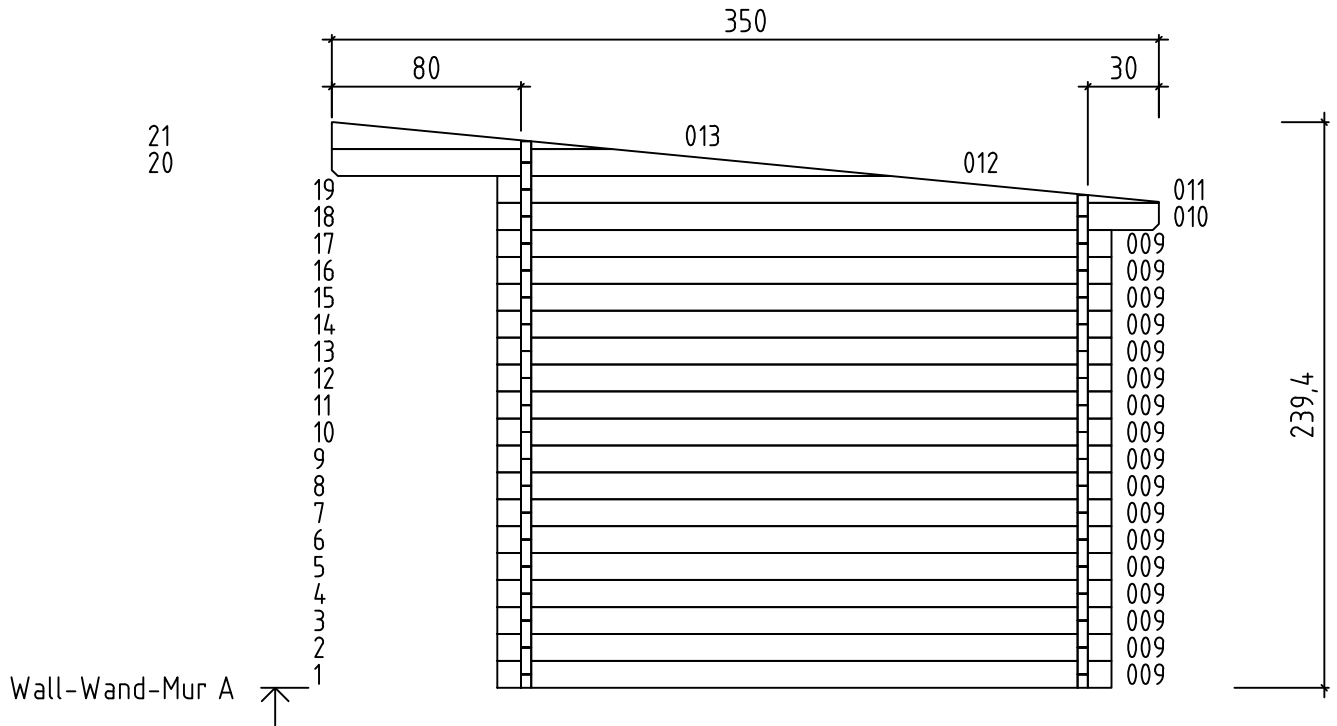



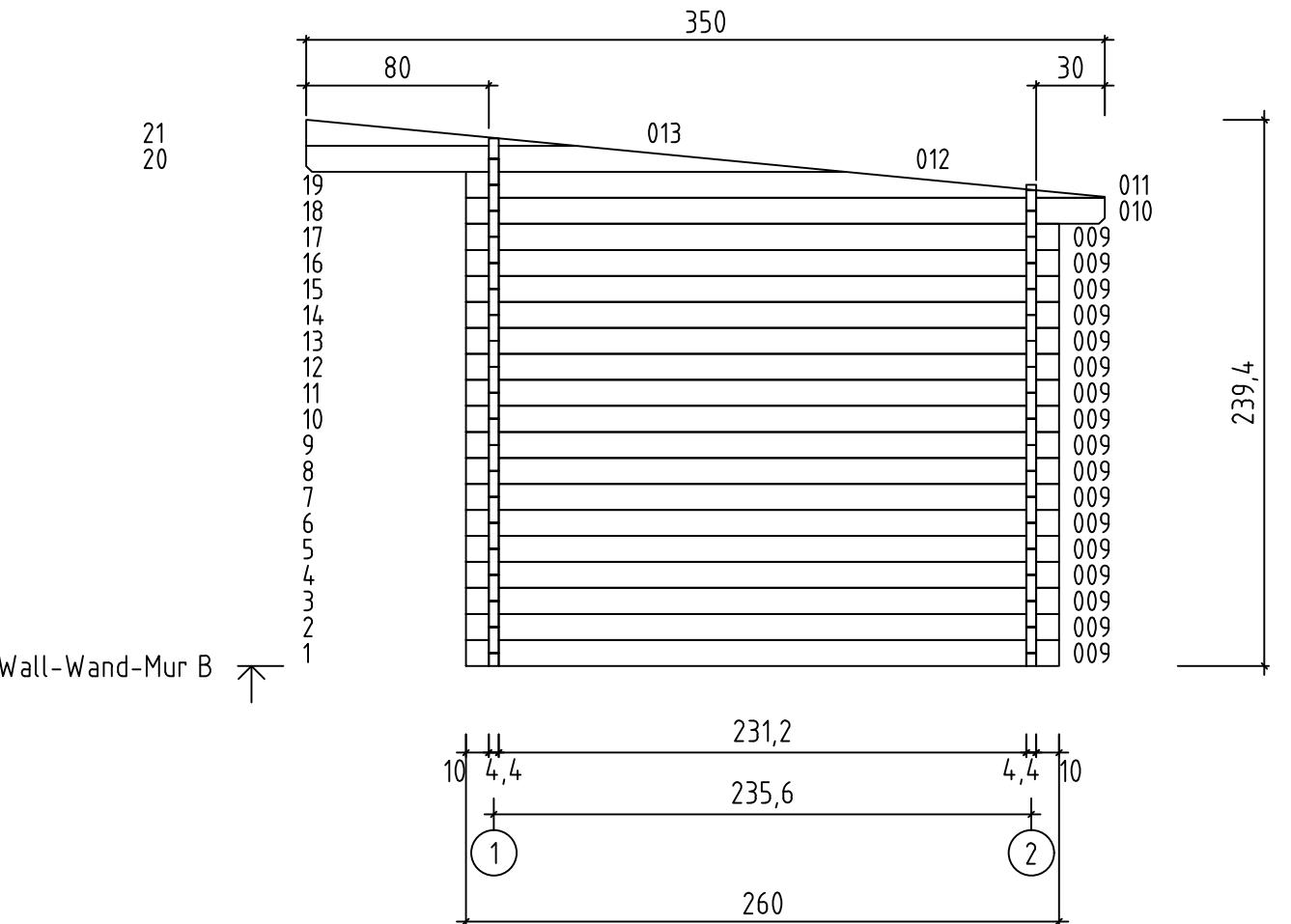



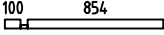
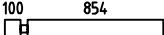

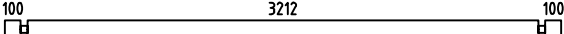
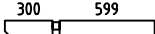
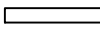
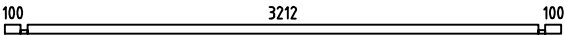
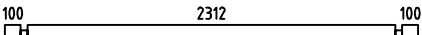
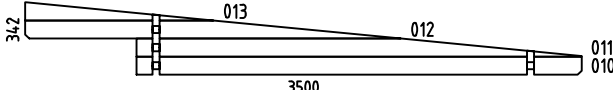
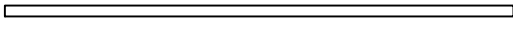
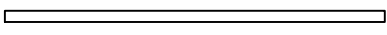
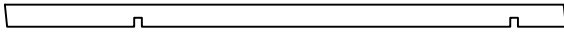

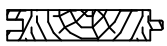





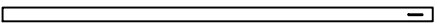

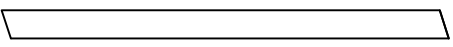

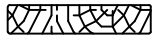

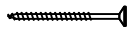
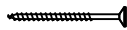
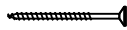
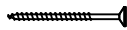
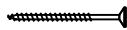
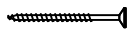
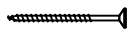
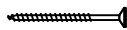
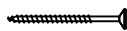
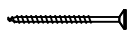
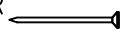

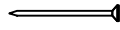
Wall-Wand-Mur A

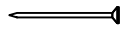
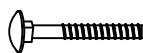

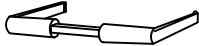
Wall-Wand-Mur B

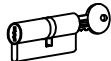
Pos	8.06.2017	Piece list - Stückliste - Liste des pièces Art.Nr. 4415040	6/8	Q	P (mm)	L (mm)
001				2	44x57	998
002				2	44x114	998
003				32	44x114	214
004				32	44x114	214
005				19	44x114	3500
006				4	44x90	943
007				6	44x90	612
008				1	44x57	3500
009				34	44x114	2600
WA-1 WB-1				1 1		
IAR2		FOUNDATION - FUNDAMENT - FONDATION		7	45x70	3200
IAR1		FOUNDATION - FUNDAMENT - FONDATION		2	45x70	2390
SR1		RAFTER - DACHSPARREN - CHEVRON		4	44x140	3530
	FLOOR BOARDS - FUSSBODENBRETTER - LAME DE PLANCHER			36	90x18	2308
	ROOF BOARDS - DACHBRETTER - VOLIGES			40	90x18	3900
	FLOOR FILLET - FUSSBODENLEISTE - CORNIERE DE FINITION DU PLANCHER				18x18	11.03
	ROOFING FELT FILLET - DACHPAPPENLEISTE - BAGUETTE DE FIXATION DU FEUTRE BITUMEUX			2	18x58	3550
	ROOFING FELT FILLET - DACHPAPPENLEISTE - BAGUETTE DE FIXATION DU FEUTRE BITUMEUX			1	18x58	3820
DRV-1	ROOF EDGE REINFORCEMENT - DACHRANDVERSTÄRKUNG - CORNIERE DE RENFORT DE BORD DE TOIT			2	28x34	300
DRV-2	ROOF EDGE REINFORCEMENT - DACHRANDVERSTÄRKUNG - CORNIERE DE RENFORT DE BORD DE TOIT			2	28x34	800
DRV-3	ROOF EDGE REINFORCEMENT - DACHRANDVERSTÄRKUNG - CORNIERE DE RENFORT DE BORD DE TOIT			2	28x34	2320
KFS-1	STORM PROTECTION - STURMLEISTE - LATTE ANTI-TEMPETE			2	22x45	2050
KFS-2	STORM PROTECTION - STURMLEISTE - LATTE ANTI-TEMPETE			2	22x45	2500
	GABLE MOULDING - GIEBELLEISTE - PLANCHE DE RIVE			2	18x120	3530

Pos	8.06.2017	Piece list - Stückliste - Liste des pièces Art.Nr. 4415040	7/8	Q	P (mm)	L (mm)
		GABLE MOULDING - GIBELLEISTE - PLANCHE DE RIVE		3	18x120	3936
FS2		WINDOW HANDLE FITTINGS - FENSTERGRIFF - POIGNEE DE FENETRE		2	FG10.AL	
HS9		SCREW FOR GABLE MOULDING - SCHRAUBEN FÜR GIBELLEISTE - VIS POUR FIXATION PLANCHE DE RIVE		52	3.5x50	
HS4		SCREW FOR DOOR FILLET - SCHRAUBE ZUR BEFESTIGUNG TÜRLEISTE - VIS POUR FIXATION BAGUETTE D'ARRET DE PORTE		5	3x30	
HS12		SCREW FOR ROOF EDGE REINFORCEMENT - SCHRAUBEN FÜR DACHRANDVERSTÄRKUNG - VIS POUR FIXATION CORNIERE RENFORT DE BORD DE TOIT		20	4x40	
HS18		SCREW FOR ROOF BEAMS - SCHRAUBEN FÜR DACHBALKEN - VIS POUR FIXATION PANNES DE TOIT		12	5x120	
HS18		SCREW FOR GABLE - SCHRAUBEN FÜR GIEBEL - VIS POUR FIXATION DES PIGNONS		6	5x120	
HS16		SCREW FOR 1. WALL BEAM - SCHRAUBE FÜR 1. BOHLENREIHE - VIS DE FIXATIONS 1ere RANGÉE DE MADRIERS AVEC POUTRELLES DE FONDATIONS		7	5x90	
HS16		SCREW FOR FOUNDATION - SCHRAUBEN ZUR BEFESTIGUNG FUNDAMENT - VIS DE FIXATIONS DES POUTRELLES DE FONDATIONS		14	5x90	
HS16		SCREW FOR DOOR JAMB - SCHRAUBE FÜR TÜRRAHMEN - VIS DE FIXATION PARTIE HAUTE AVEC MONTANTS DU CADRE DE PORTE		4	5x90	
HS23		SCREW FOR POS. 006, 007 - SCHRAUBEN FÜR POS. 006, 007 - VIS POUR POS. 006, 007		20	6x180	
HS25		SCREW FOR DOORSTEP - SCHRAUBEN FÜR SWELLE - VIS POUR FIXATION BARRE DE SEUIL		3	4.5x65	
NF2		ZN NAIL FOR FLOOR FILLET - ZN NÄGEL FÜR FUSSBODENLEISTE - POINTE POUR CORNIERE DE FINITION DU PLANCHER		23	1.4x40	
SH44		HAMMER BLOCK - SCHLAGHOLZ - CALLE DE FRAPPE		1		
SFS		NUT FOR STORM PROTECTION - SCHRAUBENMUTTER FÜR STURMLEISTE - ECROU POUR LATTE ANTI-TEMPETE		8	D8	
NF4		ZN NAIL FOR ROOF - ZN NÄGEL FÜR DACHBRETTER - POINTE POUR FIXATION VOLIGES DE TOIT		254	2x50	
NF4		ZN NAIL FOR FLOOR - ZN NÄGEL FÜR FUSSBODENBRETTER - CLOUS POUR PLANCHER		185	2x50	
NF5		ZN NAIL FOR ROOFING FELT FILLET - ZN NÄGEL FÜR DACHPAPPENLEISTE - POINTE POUR BAGUETTE DE FIXATION FEUTRE BITUMEUX		27	2x40	
BFS		BOLT FOR STORM PROTECTION - BOLZEN FÜR STURMLEISTE - BOULON POUR LATTE ANTI-TEMPETE		8	8x80	
		MALE BOLT HINGE FOR DOOR - TÜRRIEGEL - PARTIE MALE DE PAUMELLE DE PORTE		6		
DFS		WASHER FOR STORM PROTECTION - DICHTSCHEIBE FÜR STURMLEISTE - RONDELLE POUR LATTE ANTI-TEMPETE		8	D8	
TL4		DOOR HANDLE FITTINGS - TÜRGRIFF - POIGNEE DE PORTE		1		
TL5		SET OF DOOR LOCK COVERS - SCHLOSSBLENDEN - SET DE GARNITURES DE PORTE		1		
		CYLINDER LOCK - ZYLINDERSCHLOSS - BARILLET DE PORTE		1	30x35	
		STRIKER FOR BARREL BOLT - HÜLSE FÜR GRENDRIEGEL - GACHE AU SOL DU TARGETTE		2		

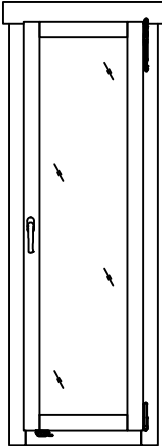
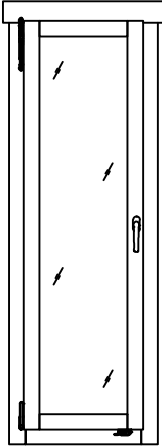
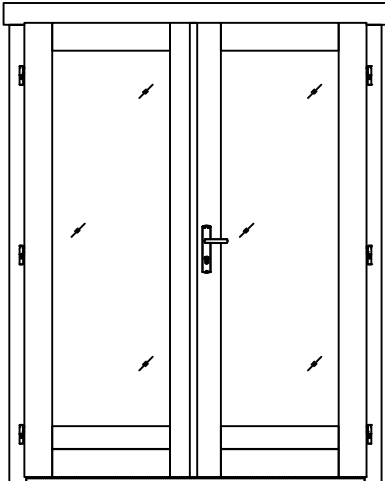
Pos	8.06.2017 Piece list - Stückliste - Liste des pièces Art.Nr. 4415040	8/8	Q	P (mm)	L (mm)
HC	COVERS FOR DOOR HINGES - SCHUTZKAPPE FÜR TÜRBAND - COUVERTURE DE PAUMELLE DE PORTE		12		
	WINDOW - FENSTER - FENETRE 560x1780 DGP+ 	AK.1.100.PSP	1		
	WINDOW - FENSTER - FENETRE 560x1780 DGP+ 	AK.1.100.PSV	1		
	DOOR - TÜR - PORTE 1494x1957 DGP+ 	TUK.1.100.PVP.MMb	1		