

Art. Nr. 2825350

1/7

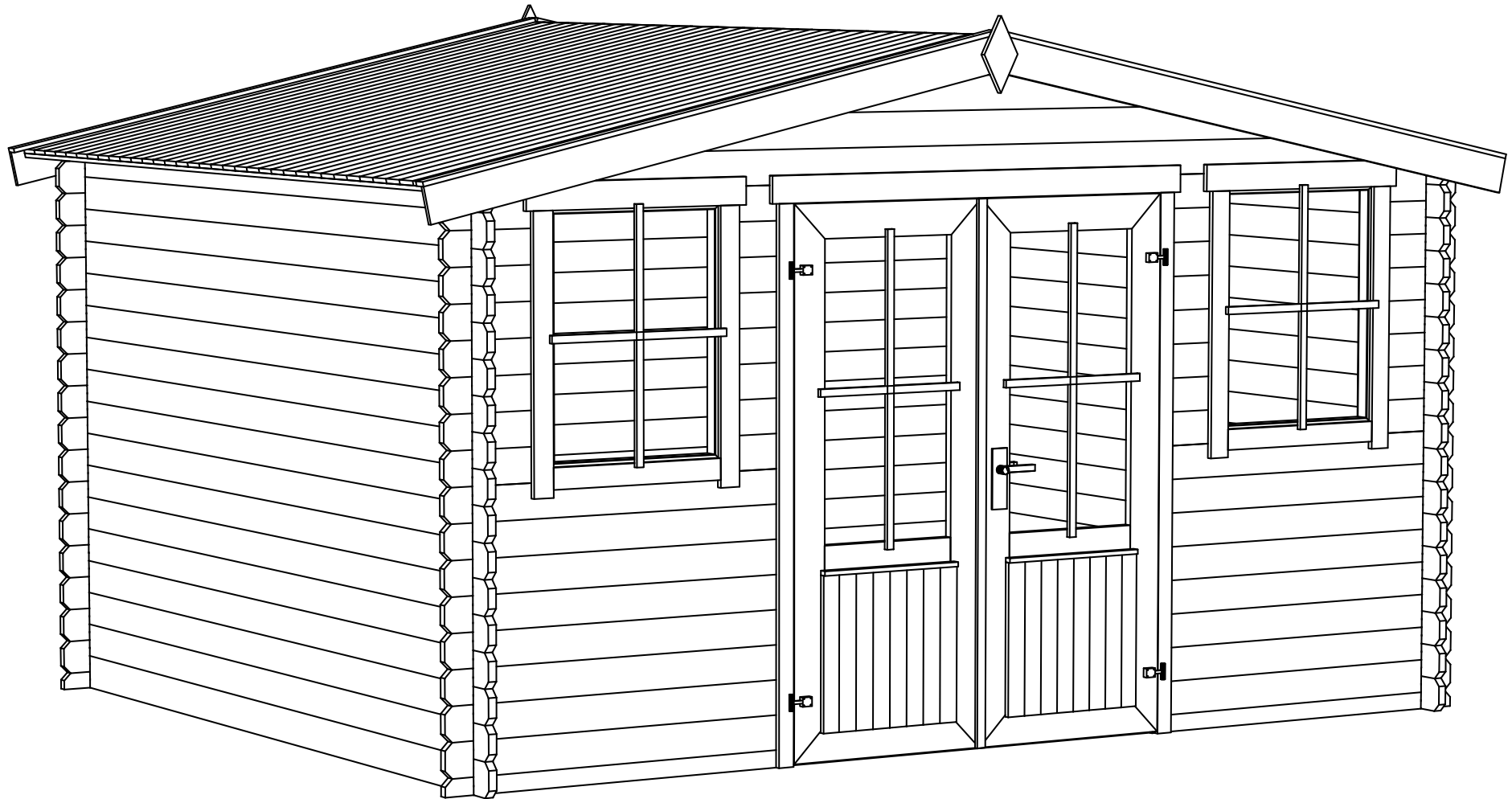

15.06.2015

Art. Nr. 2825350

GROUNDPLAN - GRUNDPLAN - PLAN DE MASSE

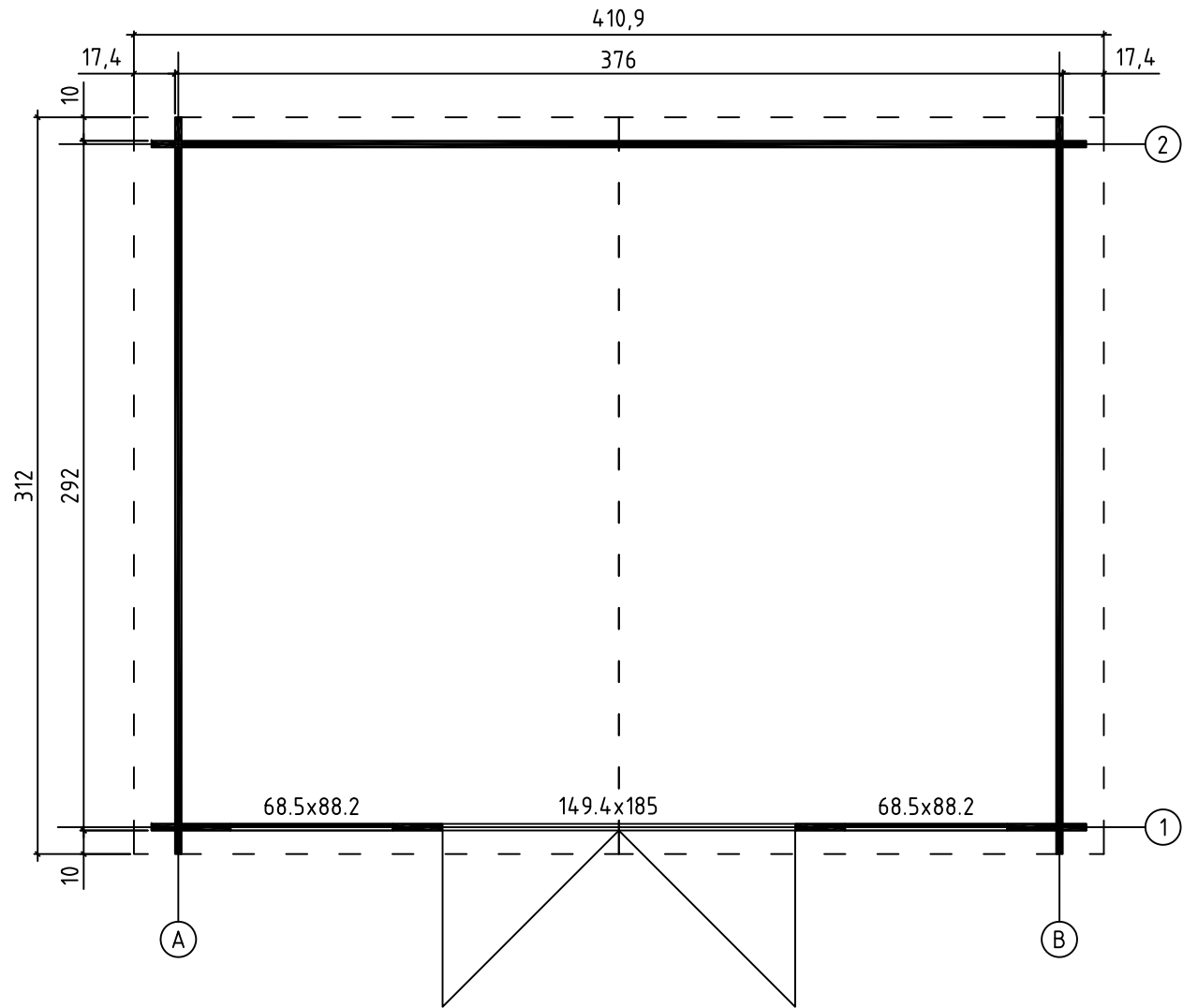





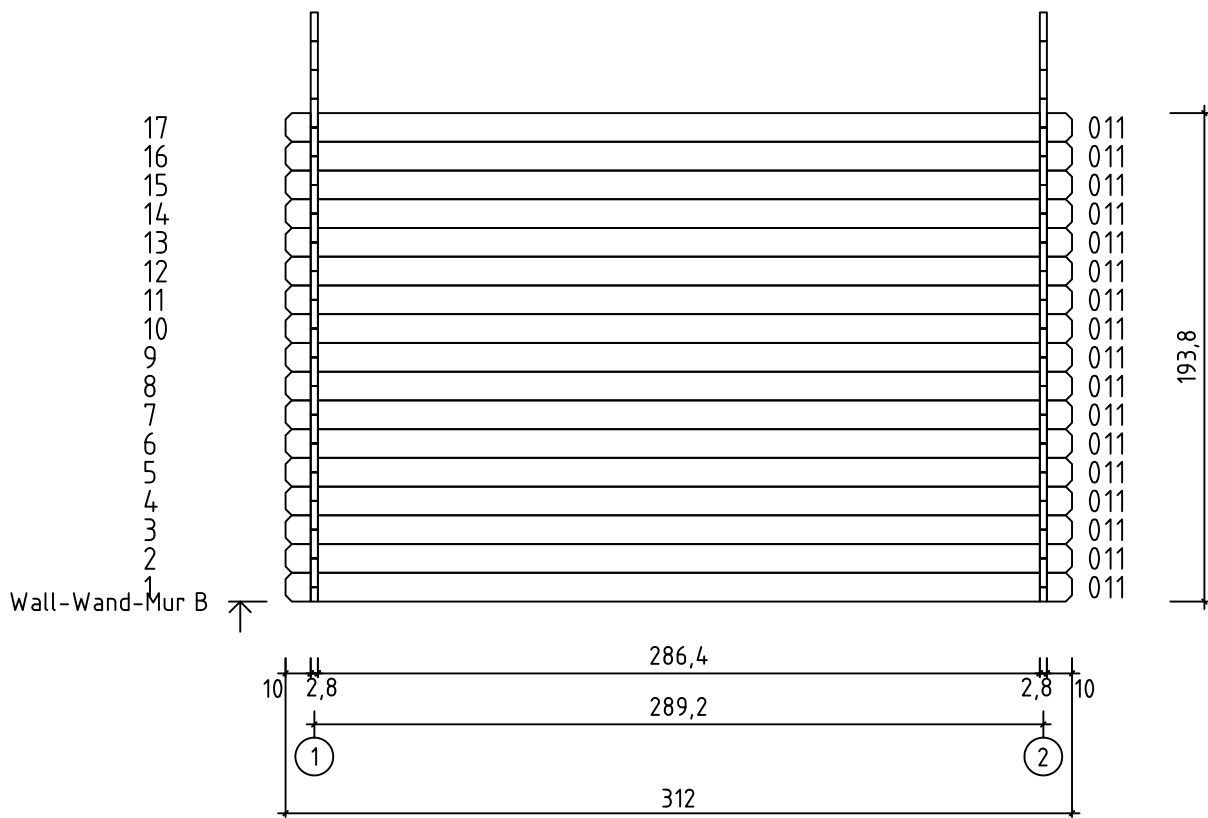
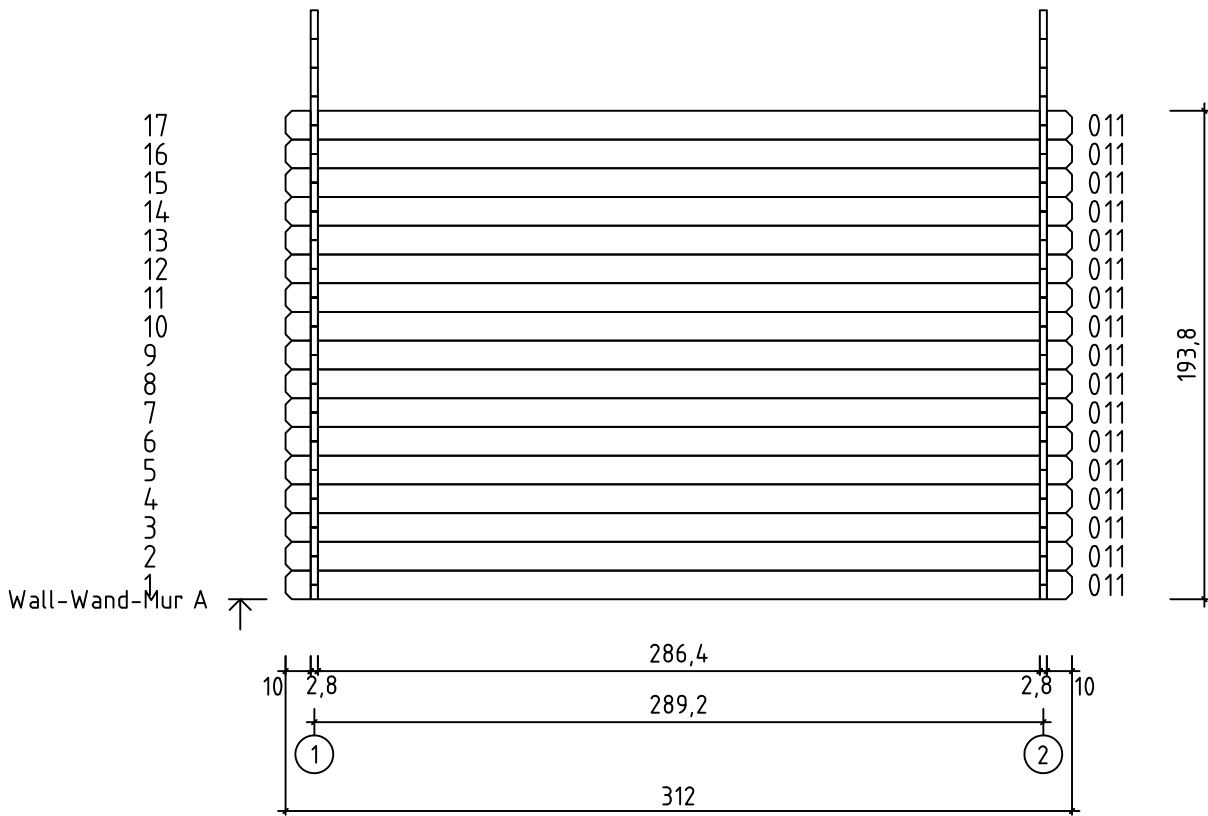



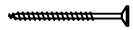
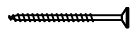
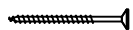

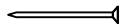
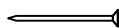

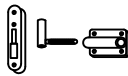
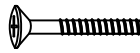
Art. Nr. 2825350



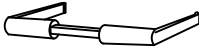

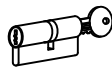
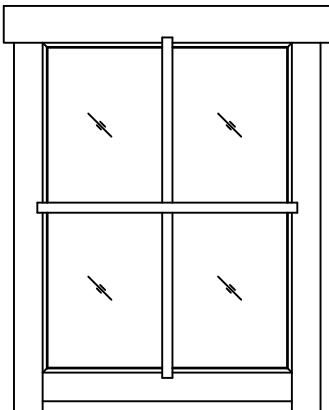

Pos	15.06.2015	Piecelist - Stücklist - Liste des composants Art. Nr. 2825350	5/7	Q.	P. (mm)	L. (mm)
001				2	28x57	1228
002				16	28x114	1228
003				16	28x114	334
004				16	28x114	205
009				1	28x57	3960
010				16	28x114	3960
011				34	28x114	3120
W1-1 W2-1				1 1		
A-PR1		ROOF BEAM - DACHBALKEN - PANNE DE TOIT		5	44x95	3120
DB	ROOF BOARDS - DACHBRETTER - VOLIGES			70	90x15	2100
	ROOFING FELT FILLET - DACHPAPPENLEISTE - BAGUETTE DE FIXATION DU FEUTRE BITUMEUX			4	15x45	2150
DRV	ROOF EDGE REINFORCEMENT - DACHRANDVERSTÄRKUNG - CORNIERE DE RENFORT DE BORD DE TOIT			2	15x45	3120
KFS	STORM PROTECTION - STURMLEISTE - - LATTE ANTI-TEMPETE			4	22x45	1880
	ROOFING FELT (STRIP) - DACHPAPPE (BAHNEN) - FEUTRE BITUMEUX (BANDE)			5		3220
	GABLE MOULDING - GIEBELLEISTE - - PLANCHE DE RIVE			4	15x120	2150
	SCREW FOR GEORGIAN BARS - SCHRAUBE FÜR SPROSSEN - VIS DE BARRES GEORGIANNE			16	2.5x20	
HS12	SCREW FOR GABLE SEGMENT - SCHRAUBEN FÜR DECKBLATT - VIS POUR FIXATION LOSANGE DE FINITION			4	3.5x35	
HS22	SCREW FOR FIXING DOOR TO THE WALL - SCHRAUBE ZUR BEFESTIGUNG TÜR - ZARGE MIT WAND - VIS DE FIXATION DORMANT DE PORTE			2	3.5x50	
HS16	SCREW FOR GABLE MOULDING - SCHRAUBEN FÜR GIEBELLEISTE - VIS DE FIXATION POUR PLANCHE DE RIVE			32	3.5x50	
HS59	SCREW FOR DOORSTEP - SCHRAUBEN FÜR SWELLE - VIS DE FIXATION DU SEUIL DE PORTE			3	3x30	
	SCREW FOR ROOF EDGE REINFORCEMENT - SCHRAUBEN FÜR DACHRANDVERSTÄRKUNG - VIS POUR RENFORT DE BORD DE TOIT			14	3x30	
HS3	SCREW FOR DOOR FILLET - SCHRAUBE ZUR BEFESTIGUNG TÜRLEISTE - VIS D'ASSEMBLAGE DU CADRE DE PORTE			5	3x30	
HS56	SCREW FOR FIXING BOLT HINGE - SCHRAUBE FÜR TÜRRIEGEL - VIS DE FIXATION POUR CHARNIERES ET GONDS DE PORTE			16	4x30	

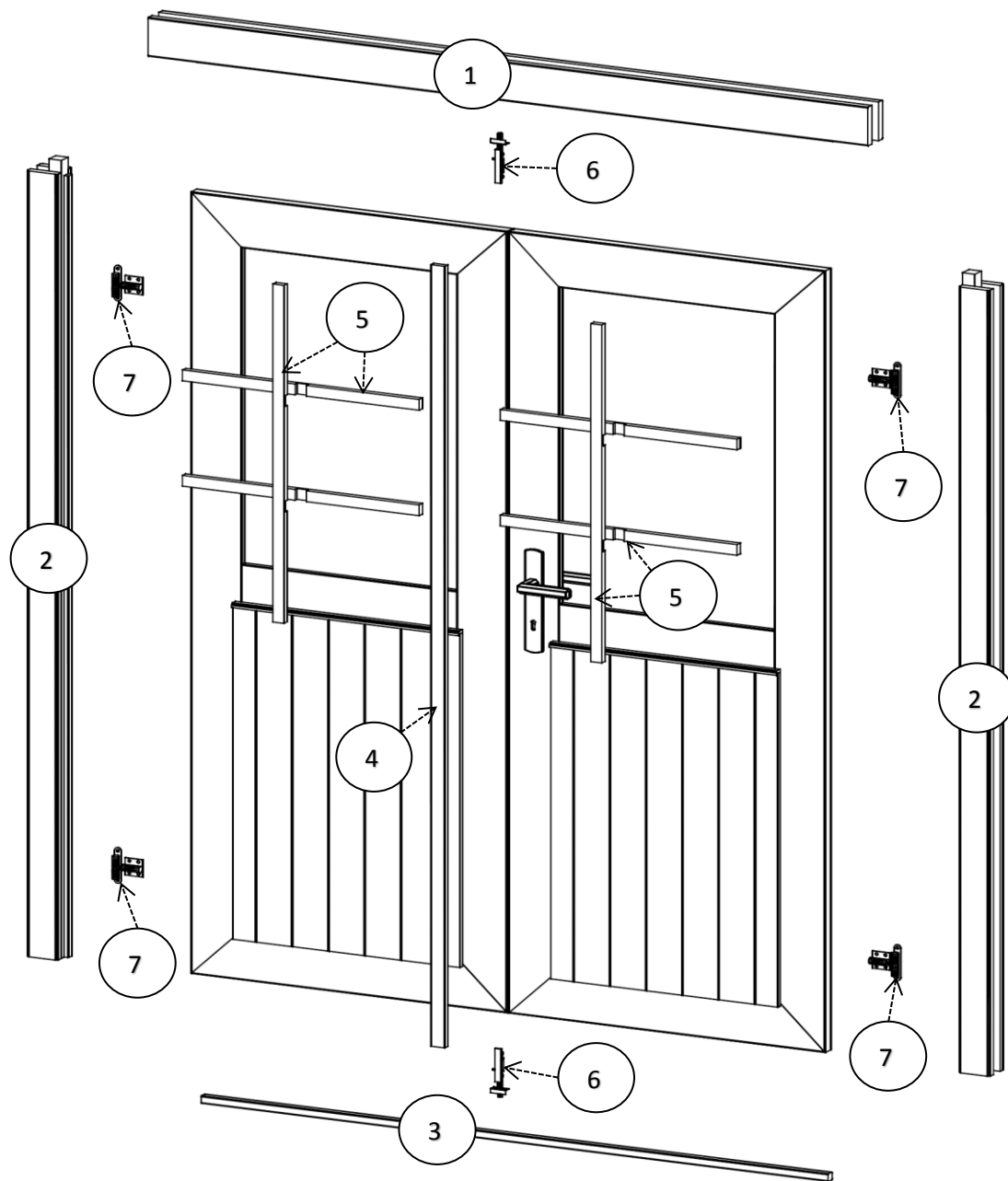
Pos	15.06.2015	Piecelist - Stücklist - Liste des composants Art. Nr. 2825350	6/7	Q.	P. (mm)	L. (mm)
HS58	SCREW FOR FIXING BOLT HINGE - SCHRAUBE FÜR TÜRRIEGEL - VIS DE FIXATION POUR CHARNIERES ET GONDS DE PORTE		12	4x40		
HS41	SCREW FOR DOOR JAMB - SCHRAUBE FÜR TÜRRAHMEN - VIS DE FIXATION POUR MONTANT DE PORTE		2	4x60		
HS43	SCREW FOR ROOF BEAMS - SCHRAUBEN FÜR DACHBALKEN - VIS POUR PANNE DE TOIT		14	5x120		
HS41	SCREW FOR DOOR JAMB - SCHRAUBE FÜR TÜRRAHMEN - VIS DE FIXATION POUR MONTANT DE PORTE		2	5x90		
SH28	HAMMER BLOCK - SCHLAGHOLZ - CALLE DE FRAPPE		1			
SFS	NUT FOR STORM PROTECTION - SCHRAUBENMUTTER FÜR STURMLEISTE - ÉCROU POUR LAME ANTI-TEMPETE		8	D6		
NF2	ZN NAIL FOR ROOF - ZN NÄGEL FÜR DACHBRETTER - POINTES DE FIXATIONS DES VOLIGES DE TOIT		300	2x50		
NFD	ZN NAIL FOR ROOFING FELT FILLET - ZN NÄGEL FÜR DACHPAPPENLEISTE - POINTE POUR BAGUETTE FIXATION FEUTRE BITUMEUX		20	2x40		
NF	ROOFING NAILS FOR ROOFING FELT - NÄGEL FÜR DACHPAPPE - POINTE DE FIXATION POUR FEUTRE BITUMEUX		132	2.8x15		
	MALE BOLT HINGE FOR DOOR - TÜRRIEGEL - PARTIE MALE DE CHARNIERE DE PORTE		4	DIN15-57		
BFS	BOLT FOR STORM PROTECTION - BOLZEN FÜR STURMLEISTE - VIS POUR LAME ANTI-TEMPETE		8	6x60		
TL	LATCH BOLT FOR DOUBLE DOOR - TORRIEGEL - LOQUET POUR DOUBLE PORTE		2		90	
GS	GABLE SEGMENT - DECKBLATT - LOSANGE DE FINITION		2			
DFS	WASHER FOR STORM PROTECTION - DICHTSCHEIBE FÜR STURMLEISTE - RONDELLE POUR LAME ANTI-TEMPETE		8	D6		
TL4	DOOR HANDLE FITTINGS - TÜRGRIFF - SET DE GARNITURES DE SERRURE DE PORTE		1			
TL5	SET OF DOOR LOCK COVERS - SCHLOSSBLENDEN - SET DE GARNITURES DE SERRURE DE PORTE		1			
	CYLINDER LOCK - ZYLINDERSCHLOSS - CYLINDRE DE SERRURE		1	30/30		
	WINDOW - FENSTER - FENETRE 685x882 XGC Plexiglass - Plexiglas - Plexiglas		AK.1.104.XM0.f	2		

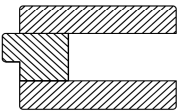
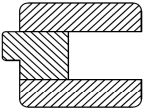

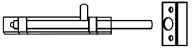
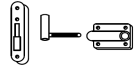

Pos	Piece list - Stückliste - Liste des pièces	Q.	P (mm)
1		1	66x100
2		2	66x80
3		1	18x18
4		1	13x32
5		6	15x25
6		2	
7		4	



