

Kensington
Art. Nr. 4414340
1/10



21.12.2016

Art.Nr. 4414340

GROUNDPLAN - GRUNDPLAN - PLAN DE MASSE

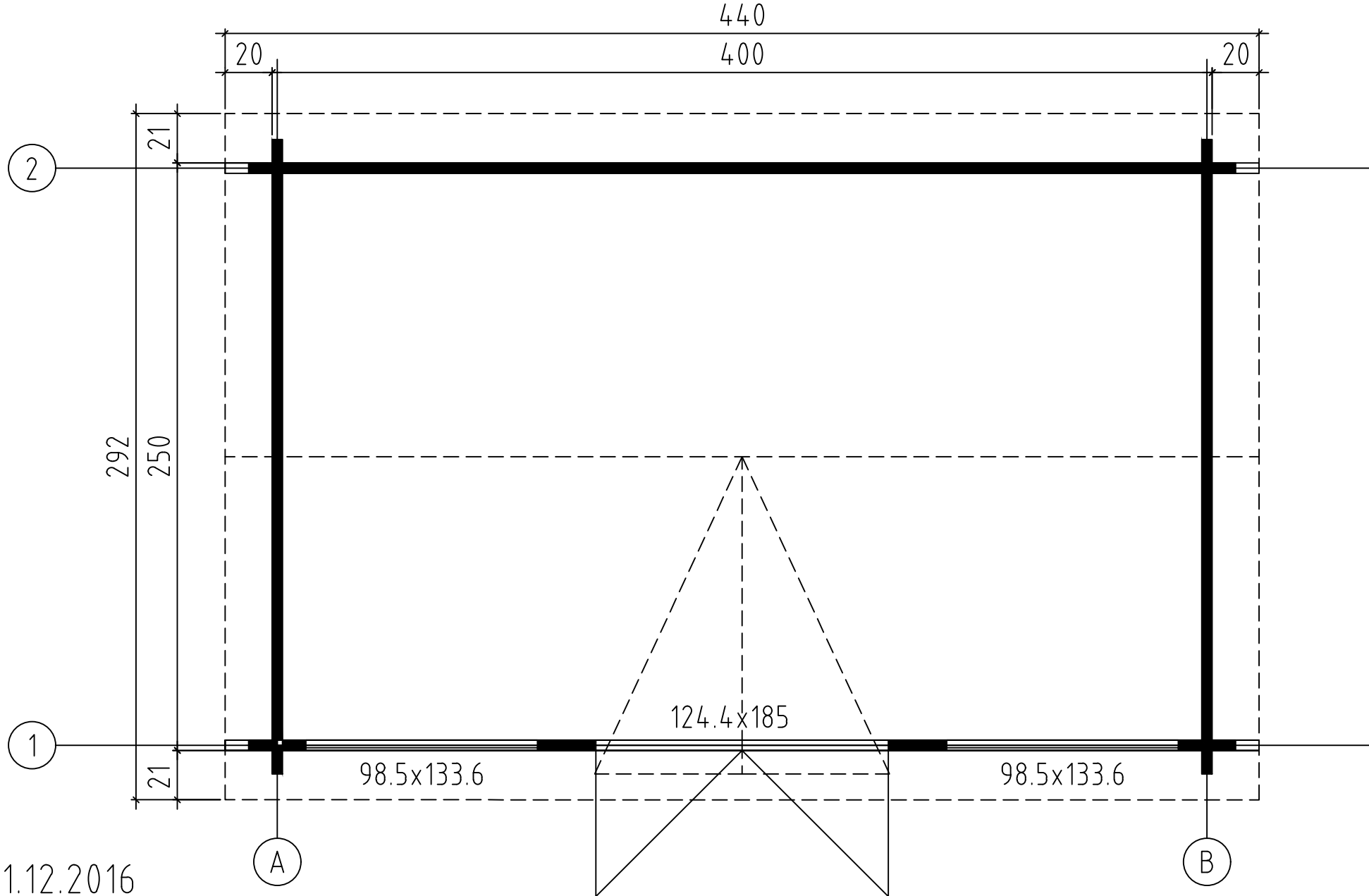

FOUNDATION - FUNDAMENT - FONDAZIONE

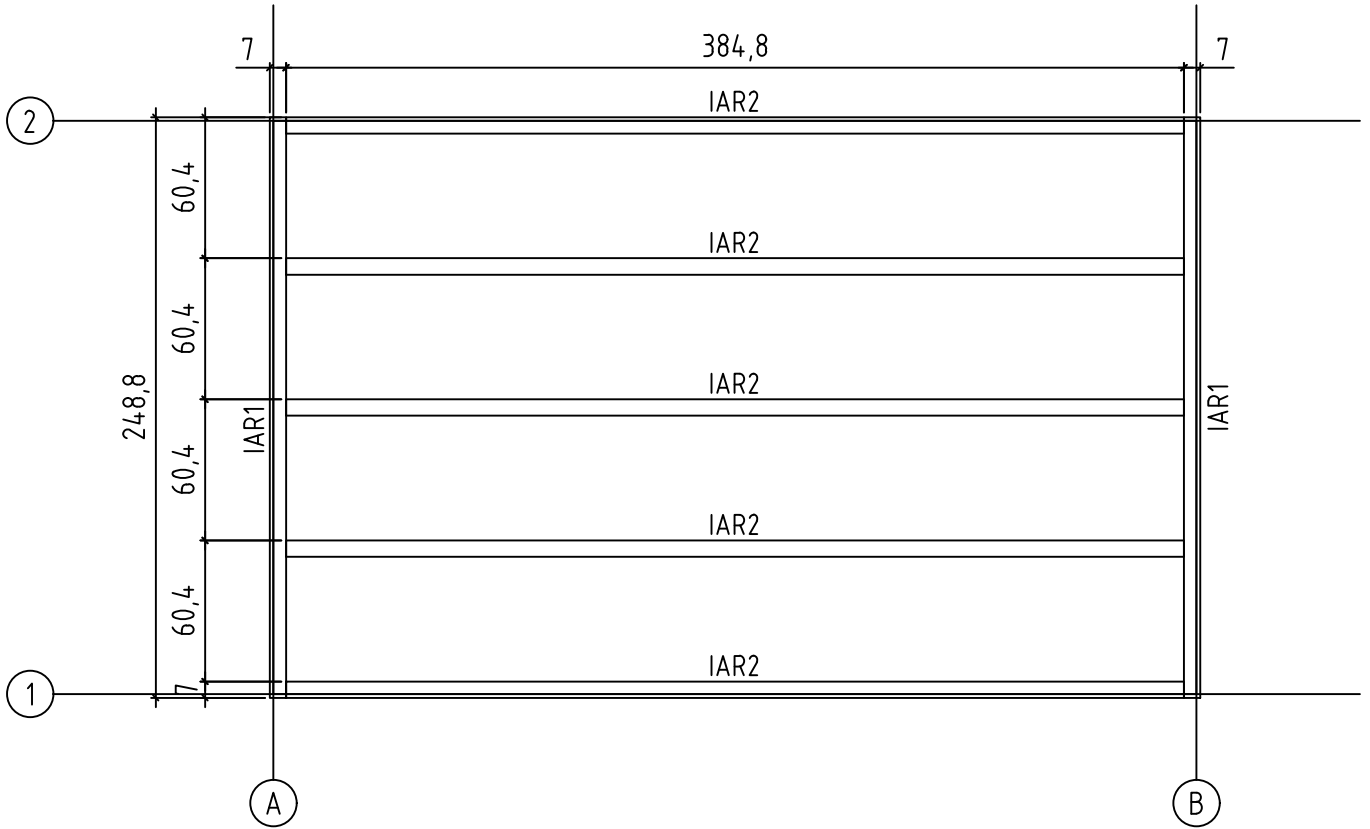

FLOOR BOARDS - FUSSBODENBRETTER - LAME DE PLANCHER

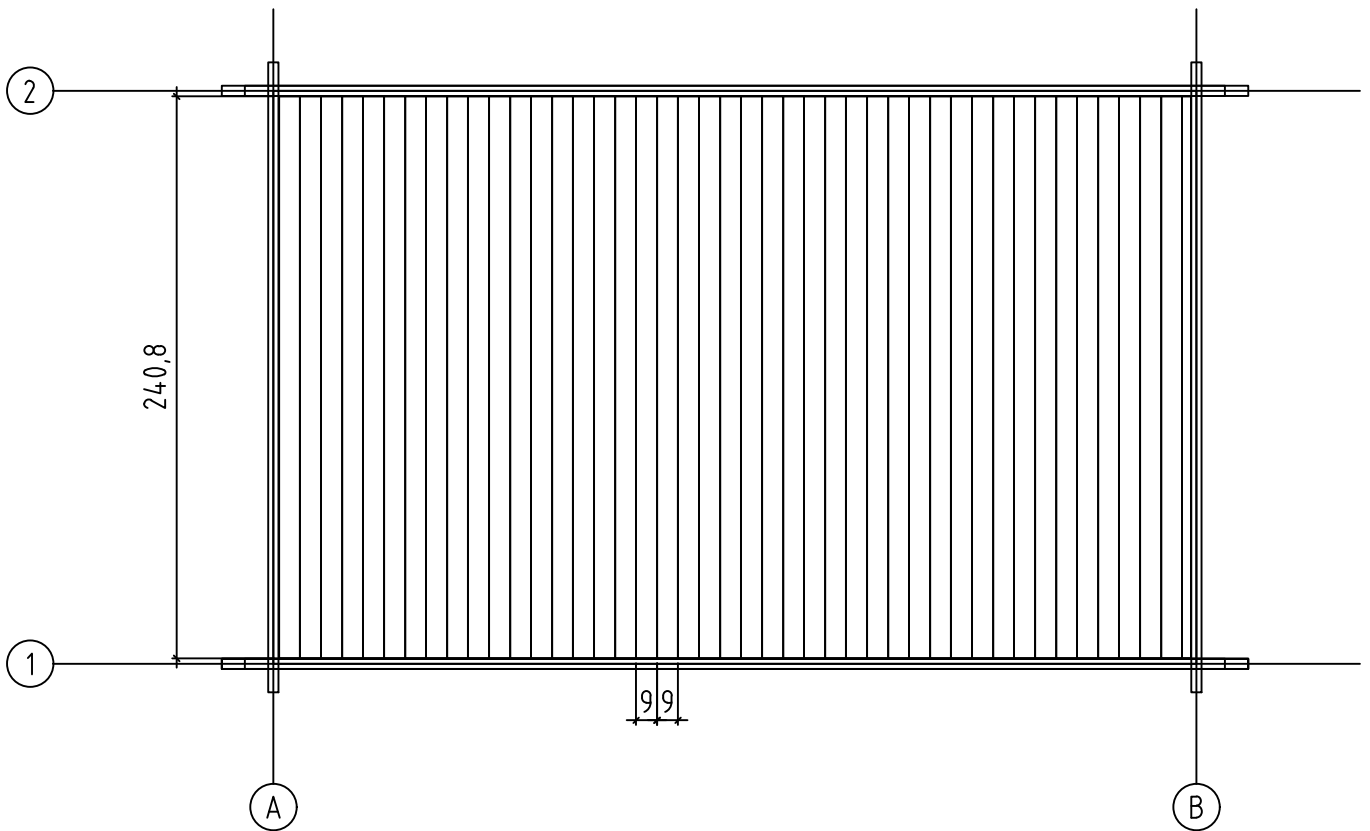

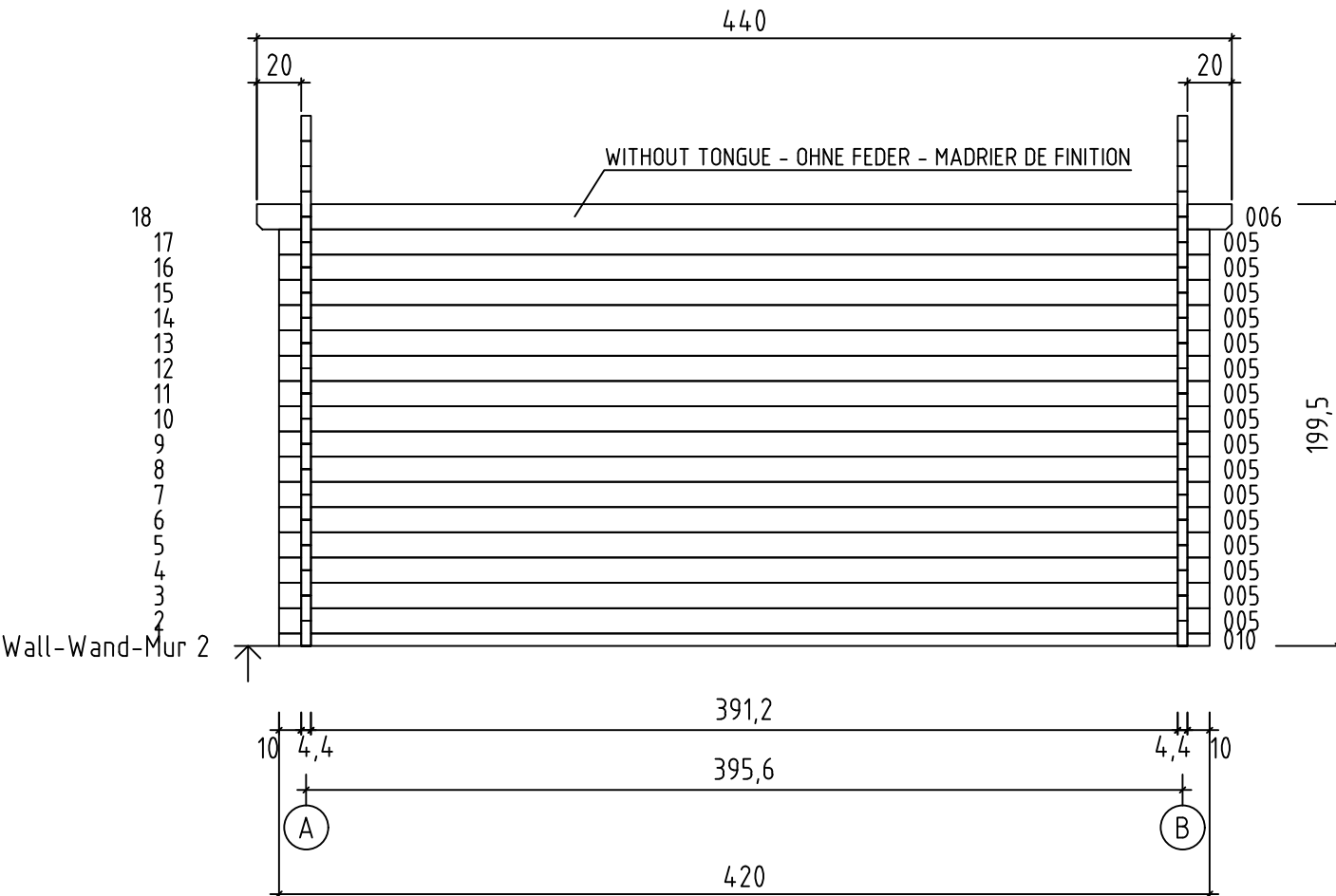
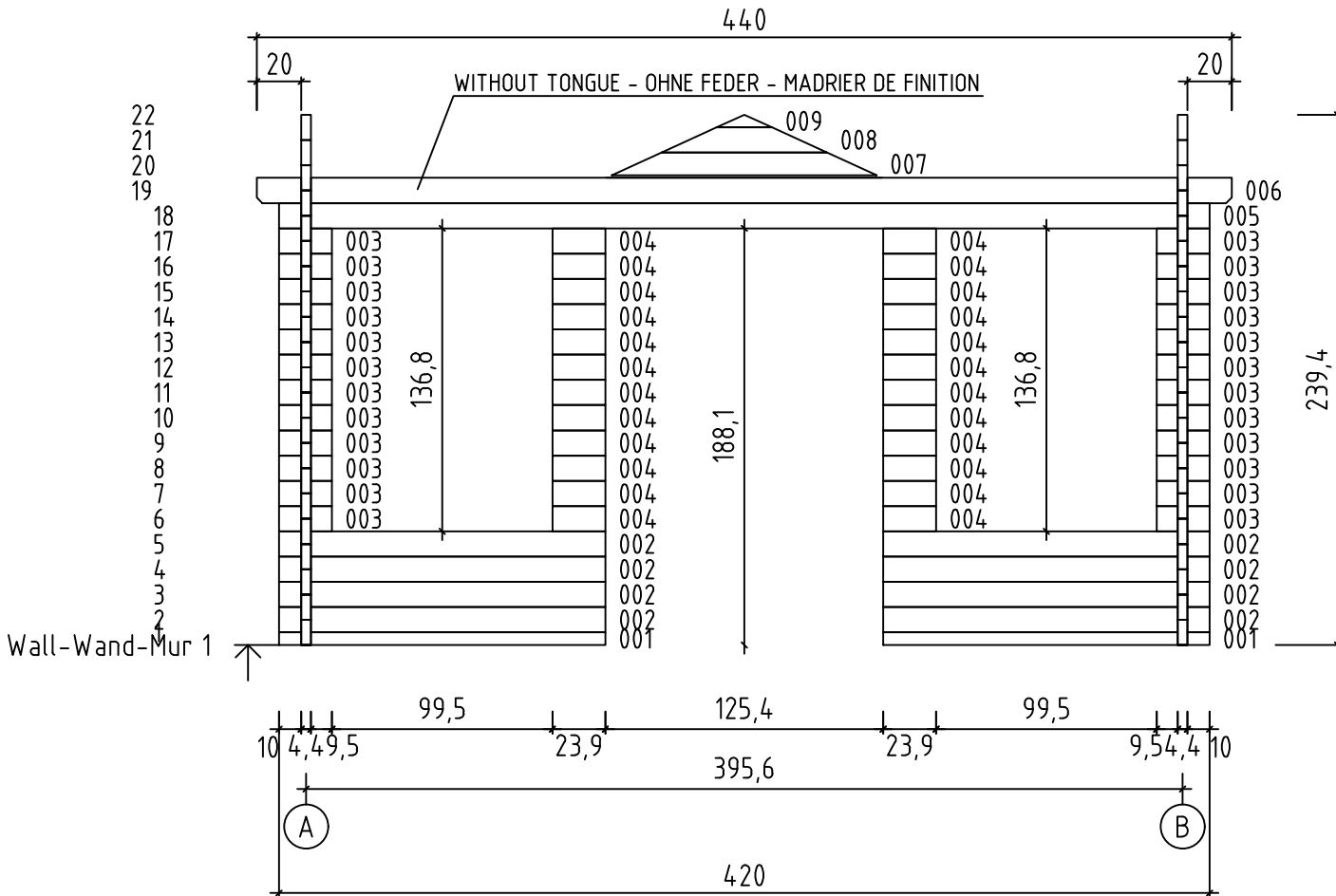

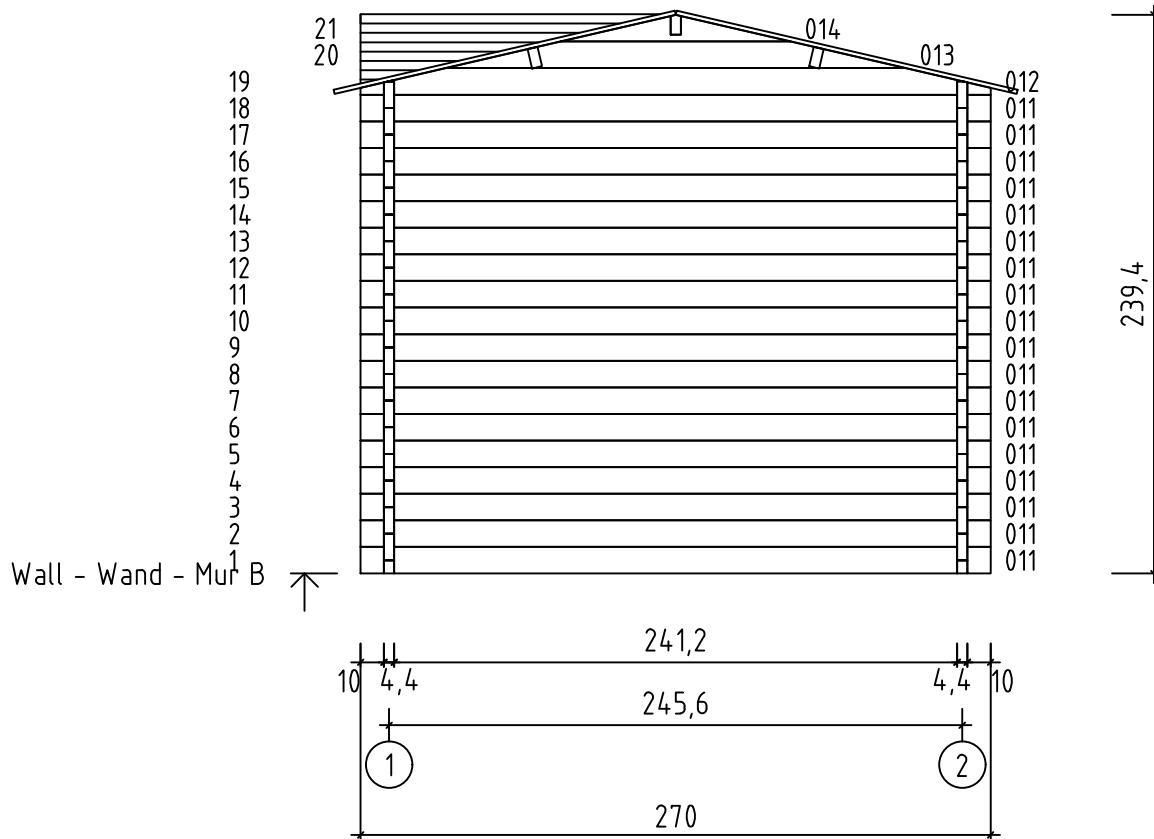
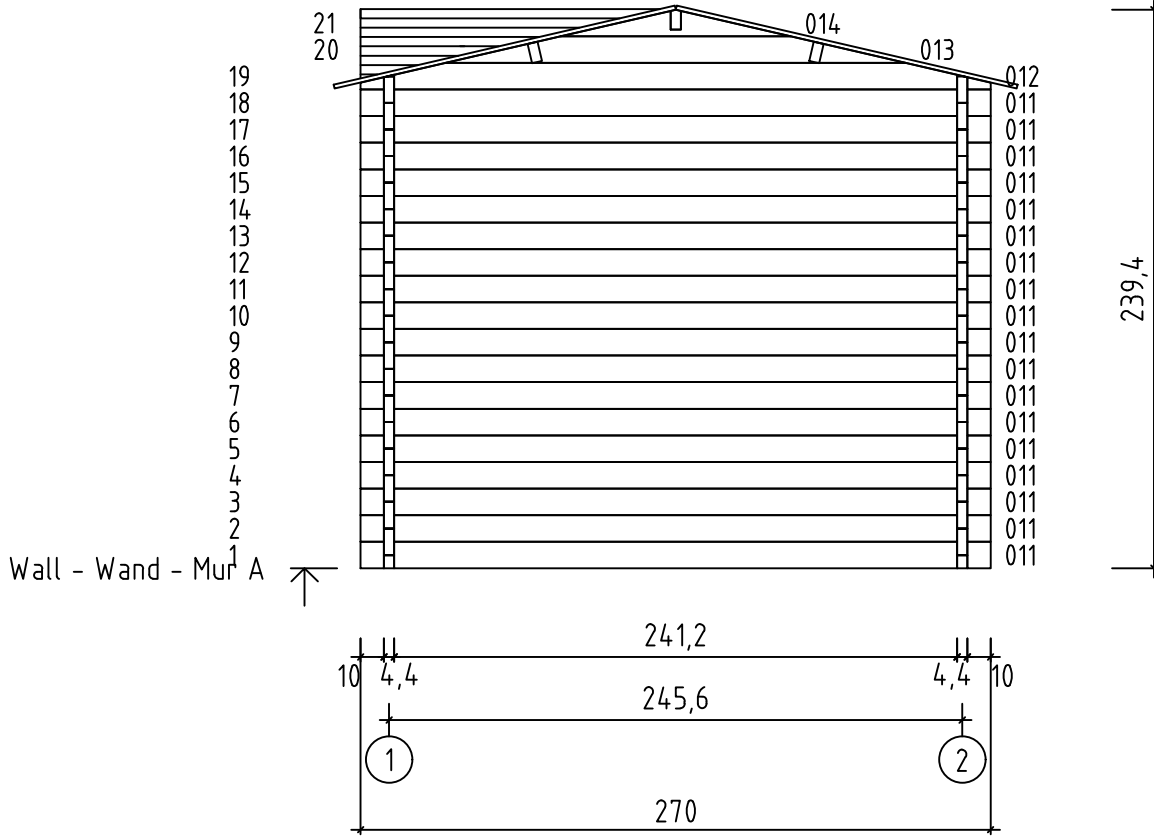







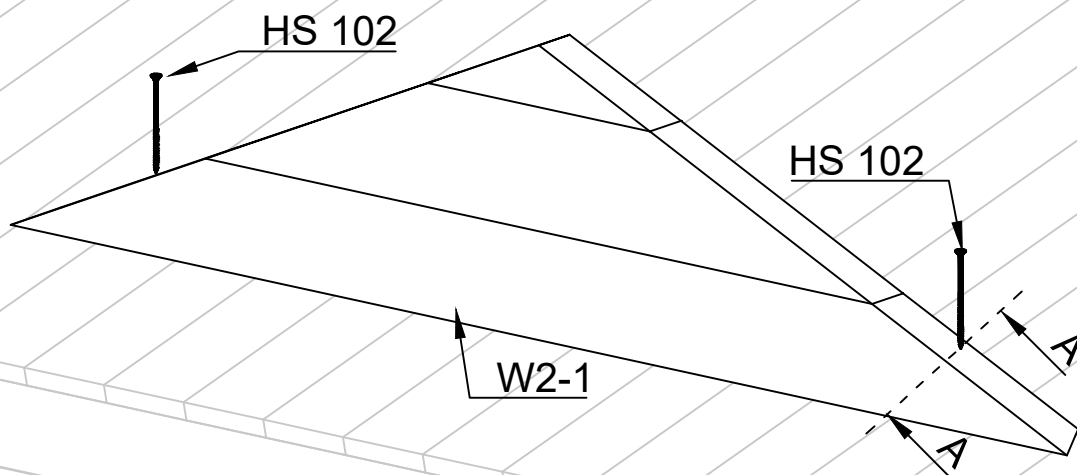
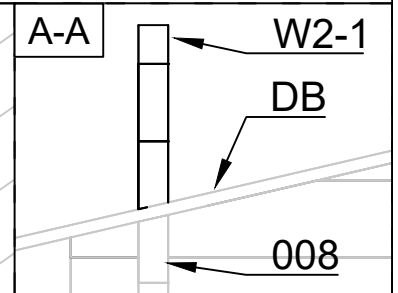
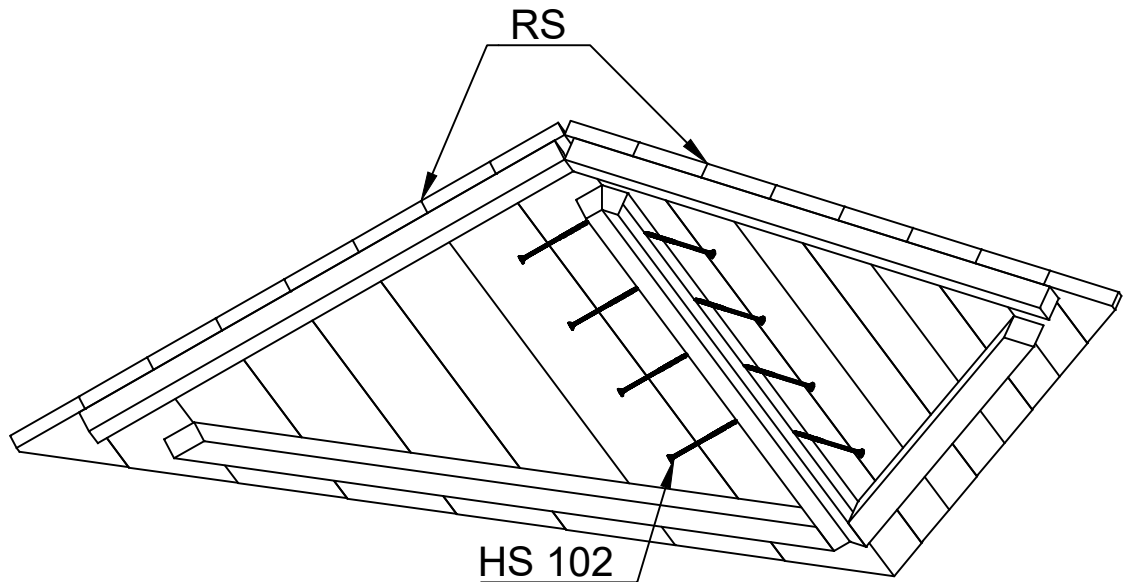

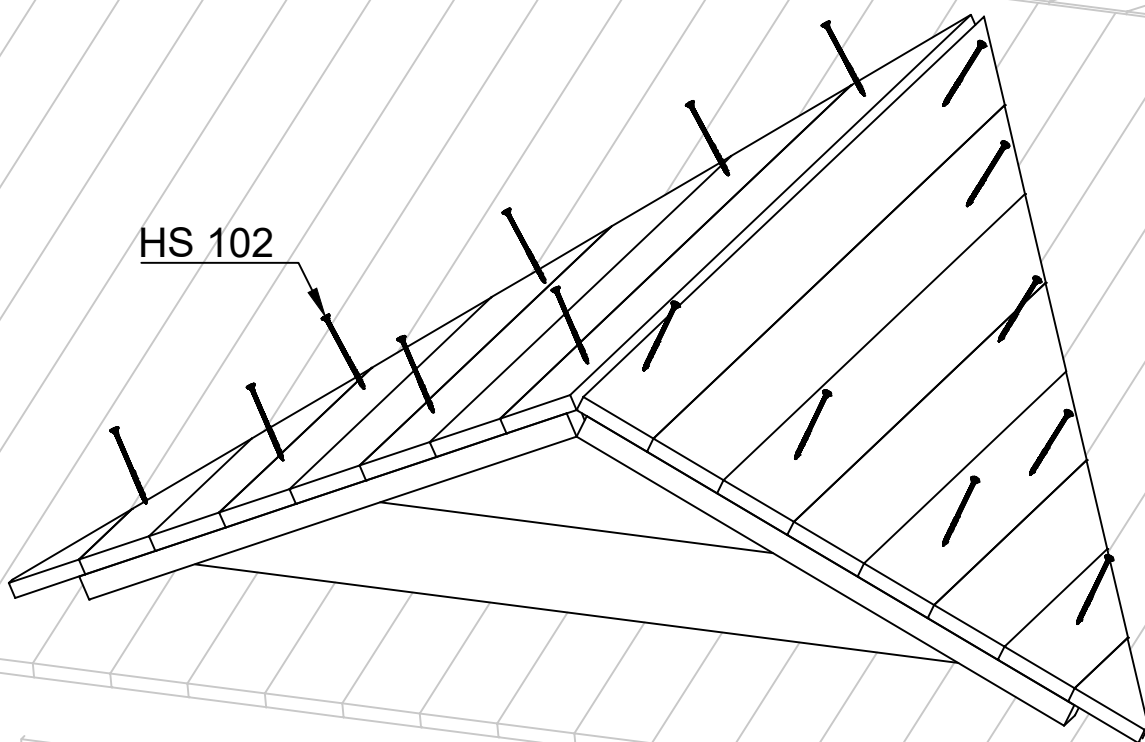
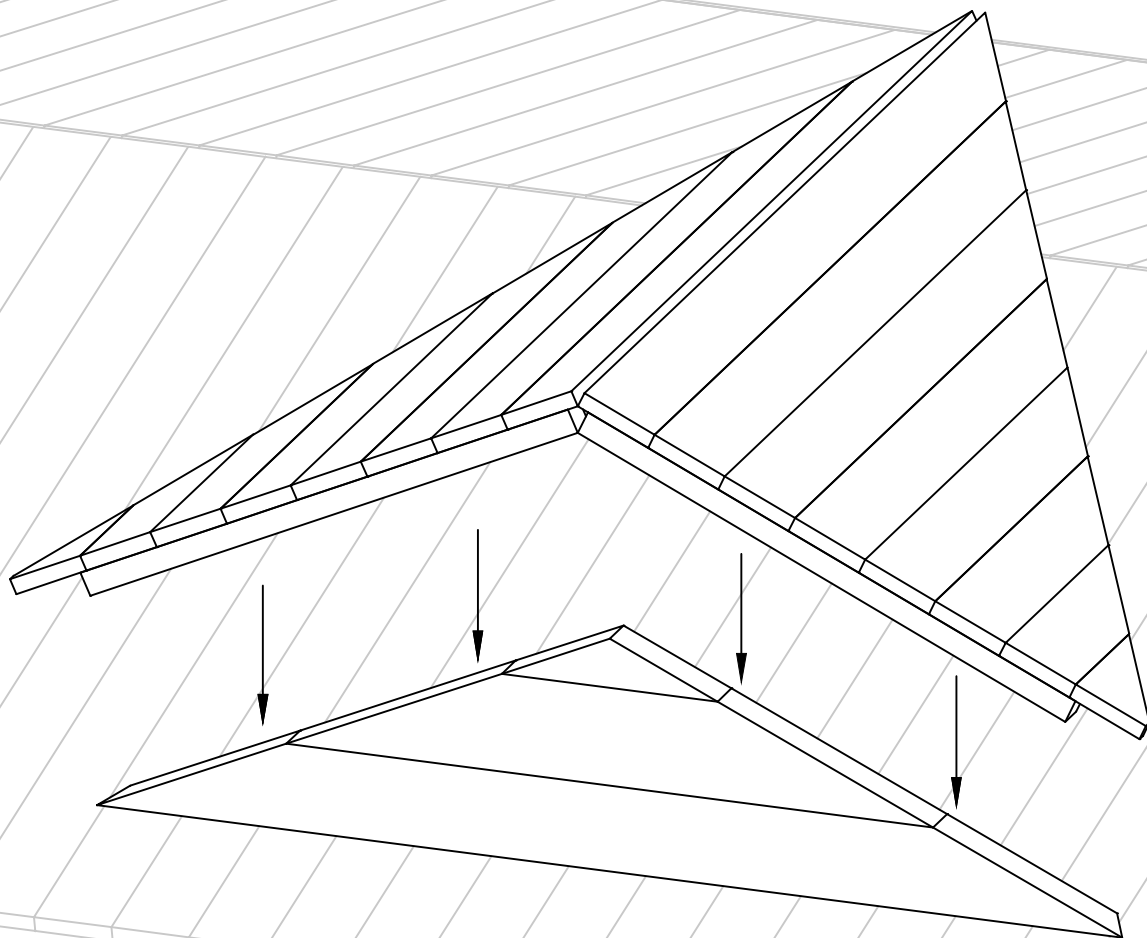

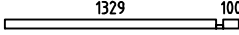
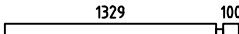

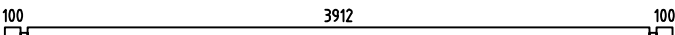
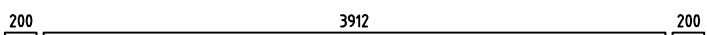
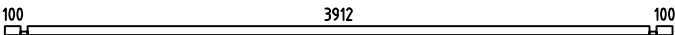
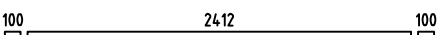
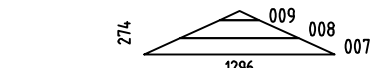
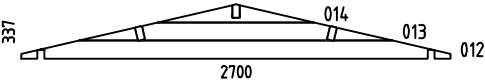
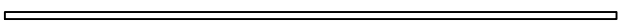
ROOFING FELT MUST BE APPLIED BEFORE APPLYING ROOF SHIELD ELEMENTS!

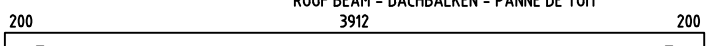
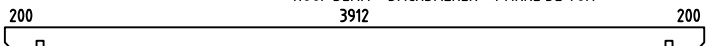

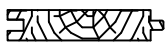



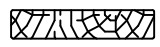

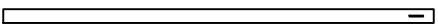
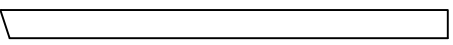
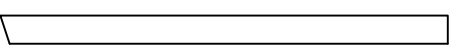
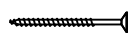

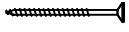
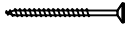
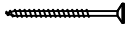
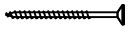
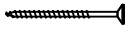
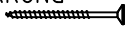

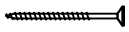
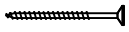
DACHPAPPE MUSS KOMPLETT AUF DEM DACH BEFESTIGT WERDEN BEVOR DAS ELEMENT - KLEINE DACHGAUBE AUFGESETZT WIRD. ANSSCHLIESSEND MUSS AUCH ÜBER DIE GAUBE EINE SCHICHT DACHPAPPE BEFESTIGT WERDEN.

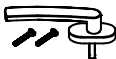
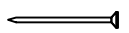

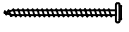
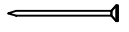
LE FEUTRE BITUMEUX DOIT ETRE POSE AVANT LES PANNEAUX DE TOITURE

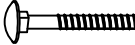

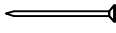
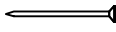
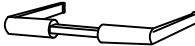

Pos	21.12.2016	Piece list - Stückliste - Liste des pièces Art.Nr. 4414340	8/10	Q.	P (mm)	L (mm)
001				2	44x57	1473
002				8	44x114	1473
003				24	44x114	244
004				24	44x114	234
005				18	44x114	4200
006				2	44x120	4400
010				1	44x57	4200
011				36	44x114	2700
W1-1				1		
WA-1				1		
WB-1			1			
IAR2		FOUNDATION - FUNDAMENT - FONDATION 		5	70x45	3848
IAR1		FOUNDATION - FUNDAMENT - FONDATION 		2	70x45	2488
PR11		ROOF BEAM - DACHBALKEN - PANNE DE TOIT 		1	44x140	4400
A.PR21		ROOF BEAM - DACHBALKEN - PANNE DE TOIT 		2	44x140	4400
FB		FLOOR BOARDS - FUSSBODENBRETTER - LAME DE PLANCHER 		44	90x18	2408
DB		ROOF BOARDS - DACHBRETTER - VOLIGES 		98	90x18	1500
FL		FLOOR FILLET-FUSSBODENLEISTE - CORNIERE DE FINITION DU PLANCHER 			18x18	12.63
DPL		ROOFING FELT FILLET - DACHPAPPENLEISTE - BAGUETTE DE FIXATION DU FEUTRE BITUMEUX 		4	18x58	1550
DPL		ROOFING FELT FILLET - DACHPAPPENLEISTE - BAGUETTE DE FIXATION DU FEUTRE BITUMEUX 		2	18x58	720
TB		EAVES BOARD - TRAUFBRETT - BANDEAU DE TOIT 		2	18x90	4400
DRV		ROOF EDGE REINFORCEMENT - DACHRANDVERSTÄRKUNG - CORNIERE DE RENFORT DE BORD DE TOIT 		2	28x34	4400
KFS		STORM PROTECTION - STURMLEISTE - LATTE ANTI-TEMPETE 		4	22x45	2050
GL		GABLE MOULDING - GIEBELLEISTE - PLANCHE DE RIVE 		4	18x120	1550
GL1		GABLE MOULDING - GIEBELLEISTE - PLANCHE DE RIVE 		2	18x90	720
HS88		VIS DE BARRES GEORGIENNE SCREW FOR GEORGIAN BARS - SCHRAUBE FÜR SPROSSEN - 		24	2.5x20	

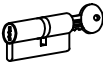
Pos	21.12.2016	Piece list - Stückliste - Liste des pièces Art.Nr. 4414340	9/10	Q.	P (mm)	L (mm)
HS89		SCREW FOR GEORGIAN BARS - SCHRAUBE FÜR SPROSSEN - VIS DE BARRES GEORGIENNE		12	2.5x20	
HS12		SCREW FOR GABLE SEGMENT - SCHRAUBEN FÜR DECKBLATT - VIS POUR FIXATION LOSANGE DE FINITION		6	3.5x50	
HS16		SCREW FOR GABLE MOULDING - SCHRAUBEN FÜR GIEBELLEISTE - VIS DE FIXATION POUR PLANCHE DE RIVE		24	3.5x50	
HS3		SCREW FOR DOOR FILLET - SCHRAUBE ZUR BEFESTIGUNG TÜRLEISTE - VIS D'ASSEMBLAGE DU CADRE DE PORTE		5	3x30	
HS32		SCREW FOR EAVES BOARDS - SCHRAUBEN FÜR TRAUFBRETT - VIS DE FIXATION POUR BANDEAU DE TOIT		20	4x40	
HS26		SCREW FOR ROOF EDGE REINFORCEMENT - SCHRAUBEN FÜR DACHRANDVERSTÄRKUNG - VIS POUR RENFORT DE BORD DE TOIT		20	4x40	
HS102		SCREW FOR ROOF SHIELD - SCHRAUBEN FÜR ELEMENT - VIS DE FIXATION DE PANNEAU DE TOITURE		27	4x60	
HS43		SCREW FOR ROOF BEAMS - SCHRAUBEN FÜR DACHBALKEN - VIS POUR PANNE DE TOIT		8	5x120	
HS40		SCREW FOR 1. WALL BEAM - SCHRAUBE FÜR 1. BOHLENREIHE - VIS DE FIXATION DES FONDATIONS		8	5x90	
HS39		SCREW FOR FUNDAMENT - SCHRAUBEN ZUR BEFESTIGUNG FUNDAMENT - VIS POUR FONDATION		10	5x90	
HS41		SCREW FOR DOOR JAMB - SCHRAUBE FÜR TÜRRAHMEN - VIS DE FIXATION POUR MONTANT DE PORTE		4	5x90	
FS3		WINDOW HANDLE FITTINGS-FENSTERGRIFF - POIGNÉE D'OUVERTURE DE FENETRE		2		
NFF		ZN NAIL FOR FLOOR FILLET - ZN NÄGEL FÜR FUSSBODENLEISTE - POINTE POUR CORNIERE DE FINITION DU PLANCHER		26	1.4x40	
SH44		HAMMER BLOCK - SCHLAGHOLZ - CALLE DE FRAPPE		1		
MS		SCREW FOR DOORSTEP - SCHRAUBEN FÜR TÜRSCHWELLE - VIS DE FIXATION DU SEUIL DE PORTE		3	4.5x65	
NFD		ZN NAIL FOR ROOFING FELT FILLET - ZN NÄGEL FÜR DACHPAPPENLEISTE - POINTE POUR BAGUETTE FIXATION FEUTRE BITUMEUX		22	2x40	
GS		GABLE SEGMENT-DECKBLATT - LOSANGE DE FINITION		3		
SFS		NUT FOR STORM PROTECTION - SCHRAUBENMUTTER FÜR STURMLEISTE - ÉCROU POUR LAME ANTI-TEMPETE		8		
BFS		BOLT FOR STORM PROTECTION - BOLZEN FÜR STURMLEISTE - VIS POUR LAME ANTI-TEMPETE		8		
DFS		WASHER FOR STORM PROTECTION - DICHTSCHEIBE FÜR STURMLEISTE - RONDELLE POUR LAME ANTI-TEMPETE		8		
NF2		ZN NAIL FOR ROOF - ZN NÄGEL FÜR DACHBRETT - POINTE POUR TOIT		306	2x50	
NH1		ZN NAIL FOR FLOOR - ZN NÄGEL FÜR FUSSBODENBRETT - CLOUS POUR PLANCHER		225	2x50	
TS3		DOOR HANDLE FITTINGS-TÜRGRIF - SET DE GARNITURES DE SERRURE DE PORTE		1		
TS4		SET OF DOOR LOCK COVERS - SCHLOSSBLENDEN - SET DE GARNITURES DE SERRURE DE PORTE		1		
TS2		MALE BOLT HINGE FOR DOOR - TÜRRIEGEL - PARTIE MALE DE CHARNIERE DE PORTE		6	14x80	

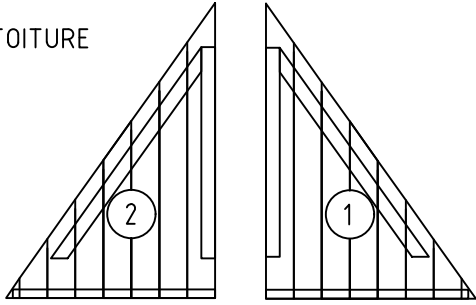
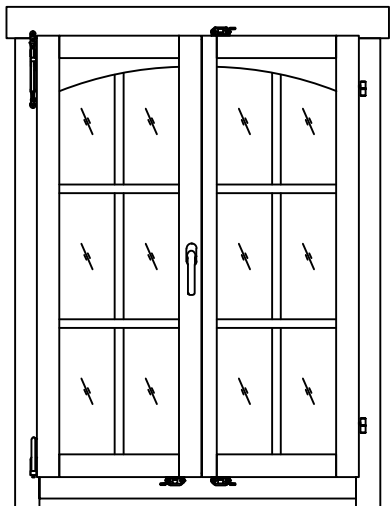
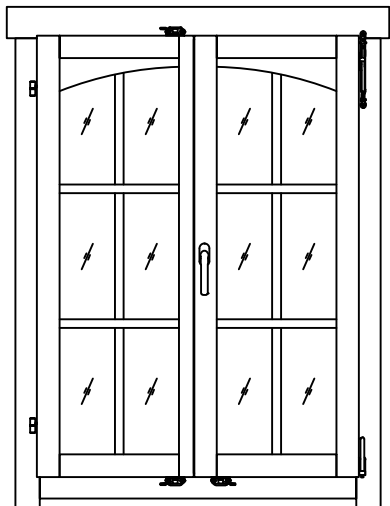
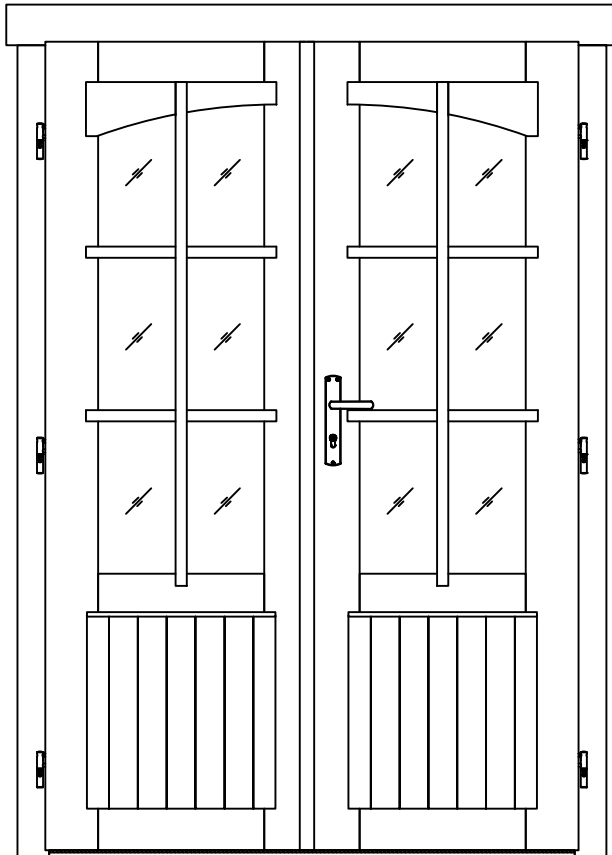
Pos	21.12.2016	Piece list - Stückliste - Liste des pièces Art.Nr. 4414340	10/10	Q.	P (mm)	L (mm)
TS6		CYLINDER LOCK - ZYLINDERSCHLOSS - CYLINDRE DE SERRURE		1	30x35	
HC		COVERS FOR DOOR HINGES - SCHUTZKAPPE FÜR TÜRBAND - COUVERTURE DE PAUMELLE DE PORTE		12		
		STRIKER FOR BARREL BOLT - HÜLSE FÜR GRENDLRIEGEL - GACHE AU SOL DU TARGETTE		2		
RS		ROOF SHIELD - ELEMENT - PANNEAU DE TOITURE		2		
		WINDOW - FENSTER - FENETRE 985x1336 TAK.1.106.PSV.Kf DGP+A+		1		
		TAK.1.106.PSP.Kf DGP+A+		1		
		DOOR - TÜR - PORTE 1244x1850		1		
		TUK.2.066.PVP.MMKWe DGP+A+				