

Art. Nr. 2822850

1/6

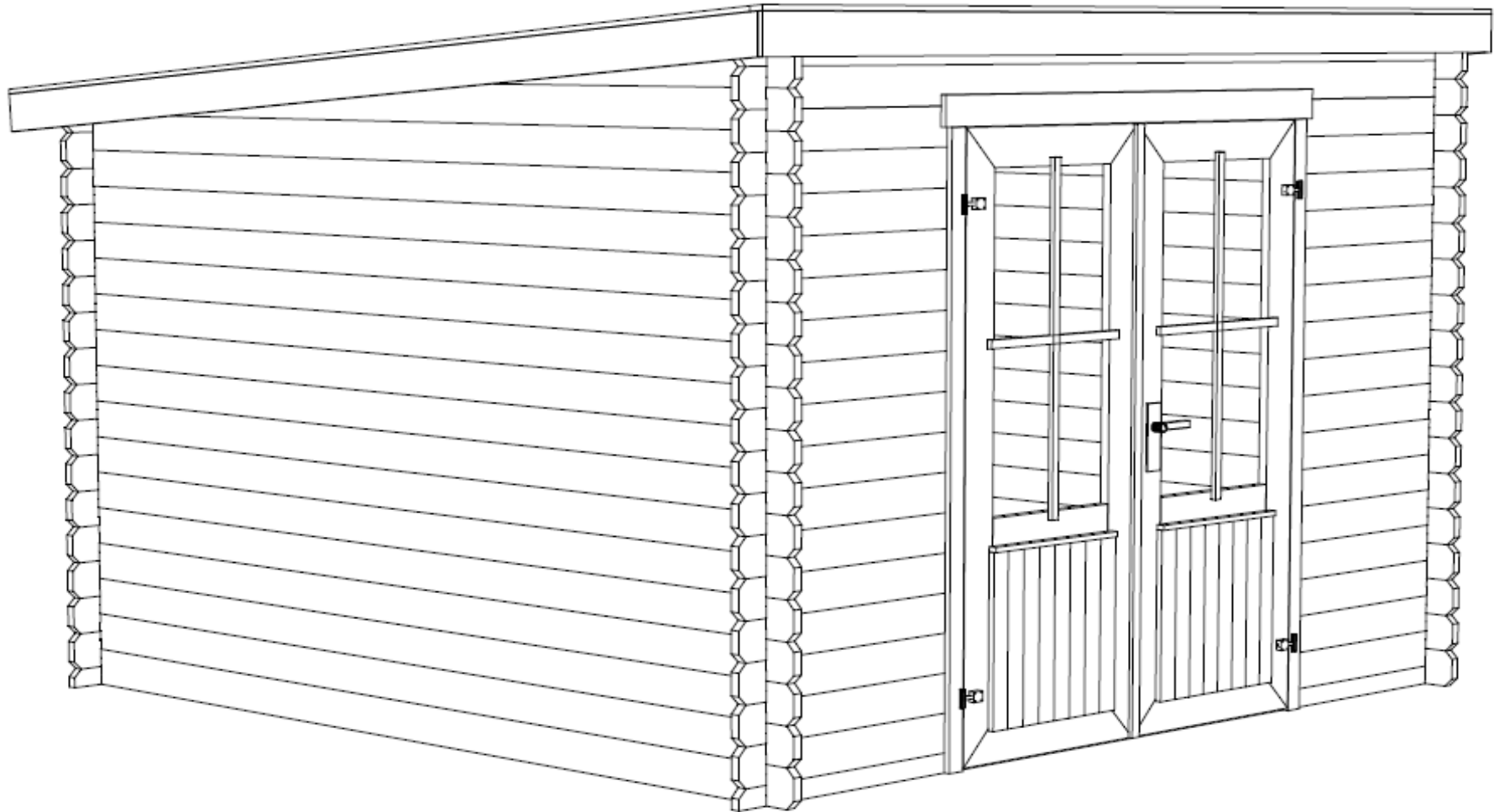

3.06.2015

Art. Nr. 2822850

GROUNDPLAN - GRUNDPLAN - PLAN DE MASSE

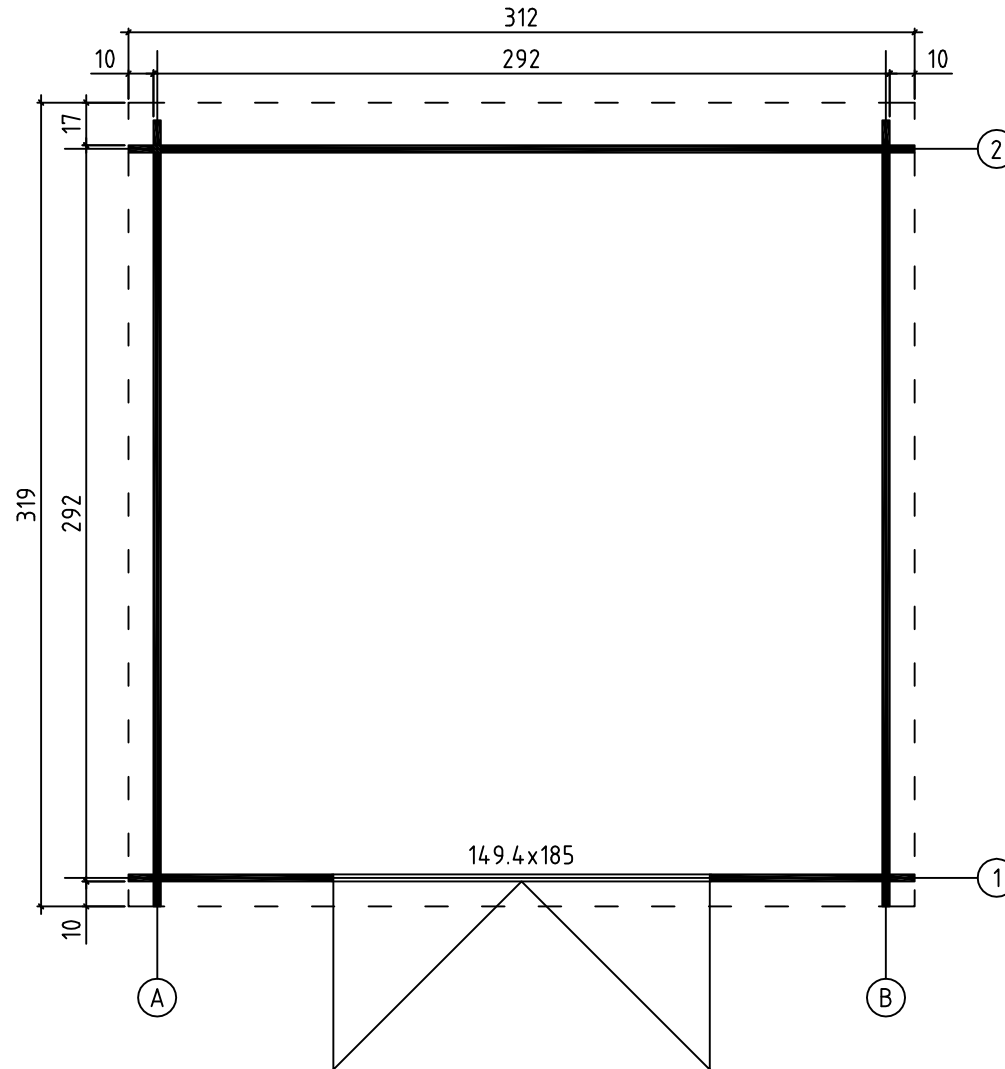



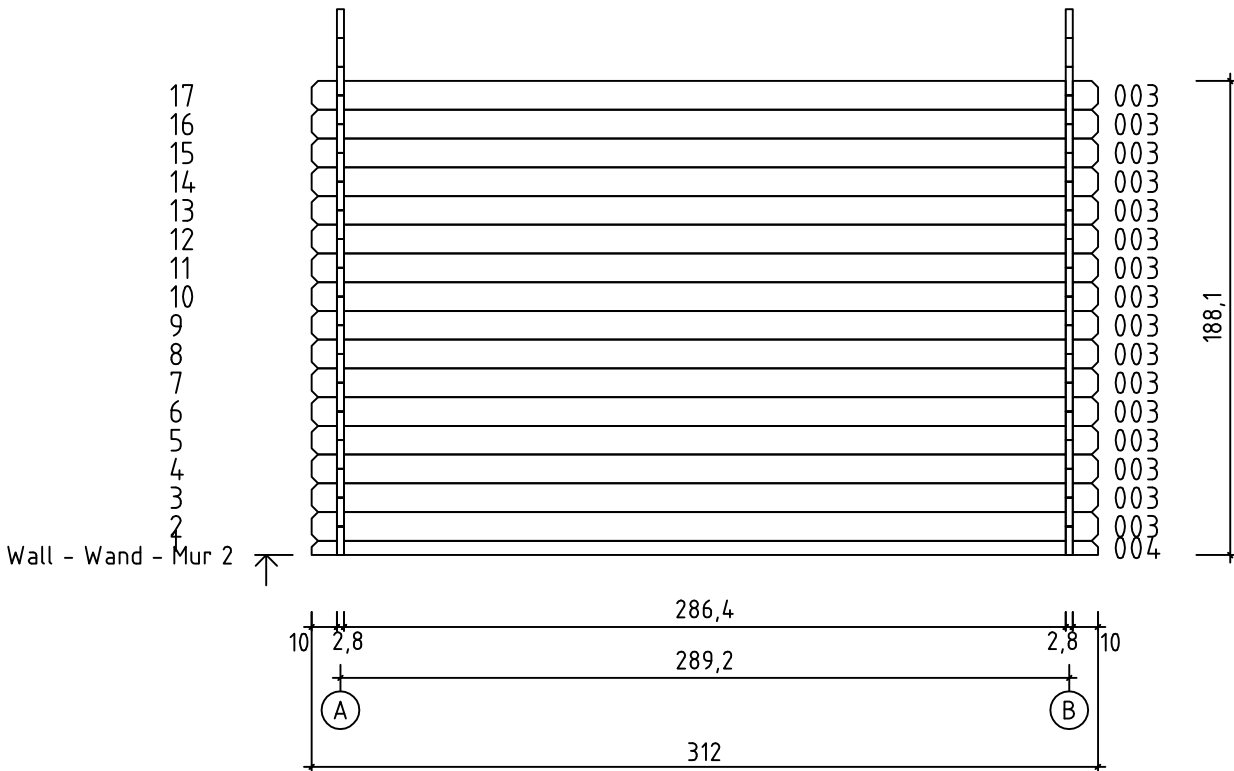
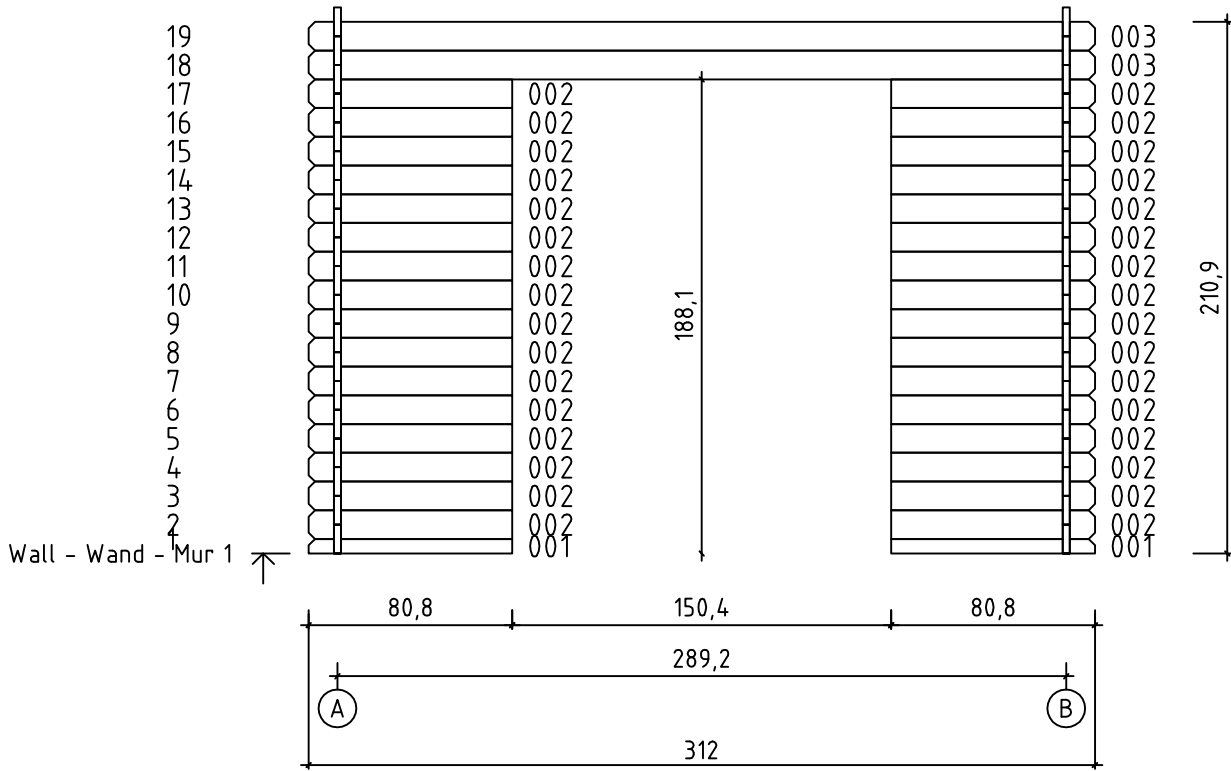



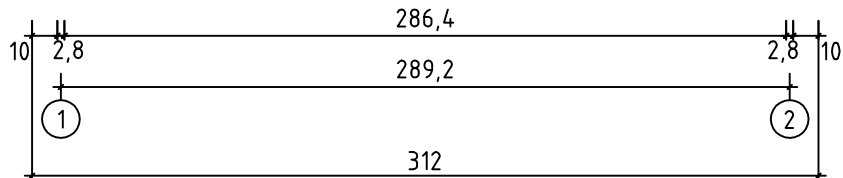
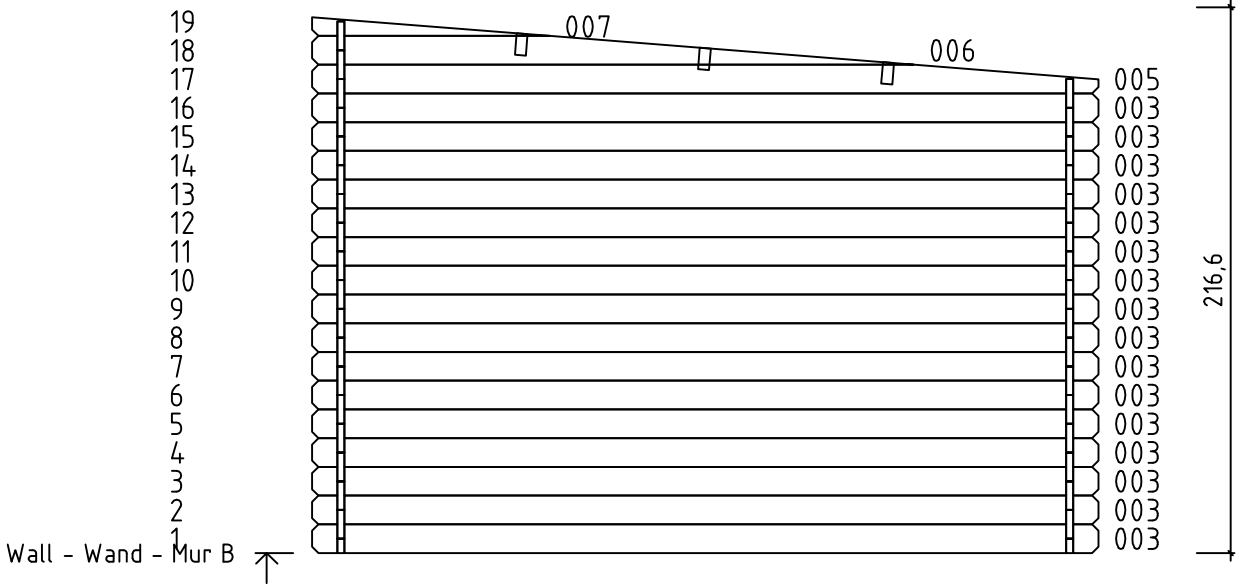
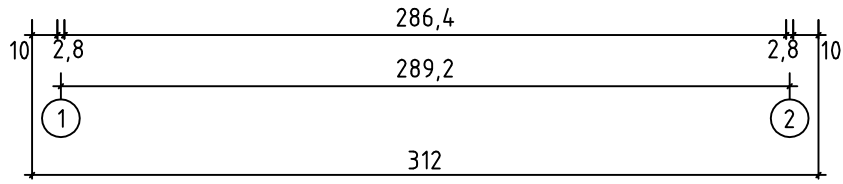
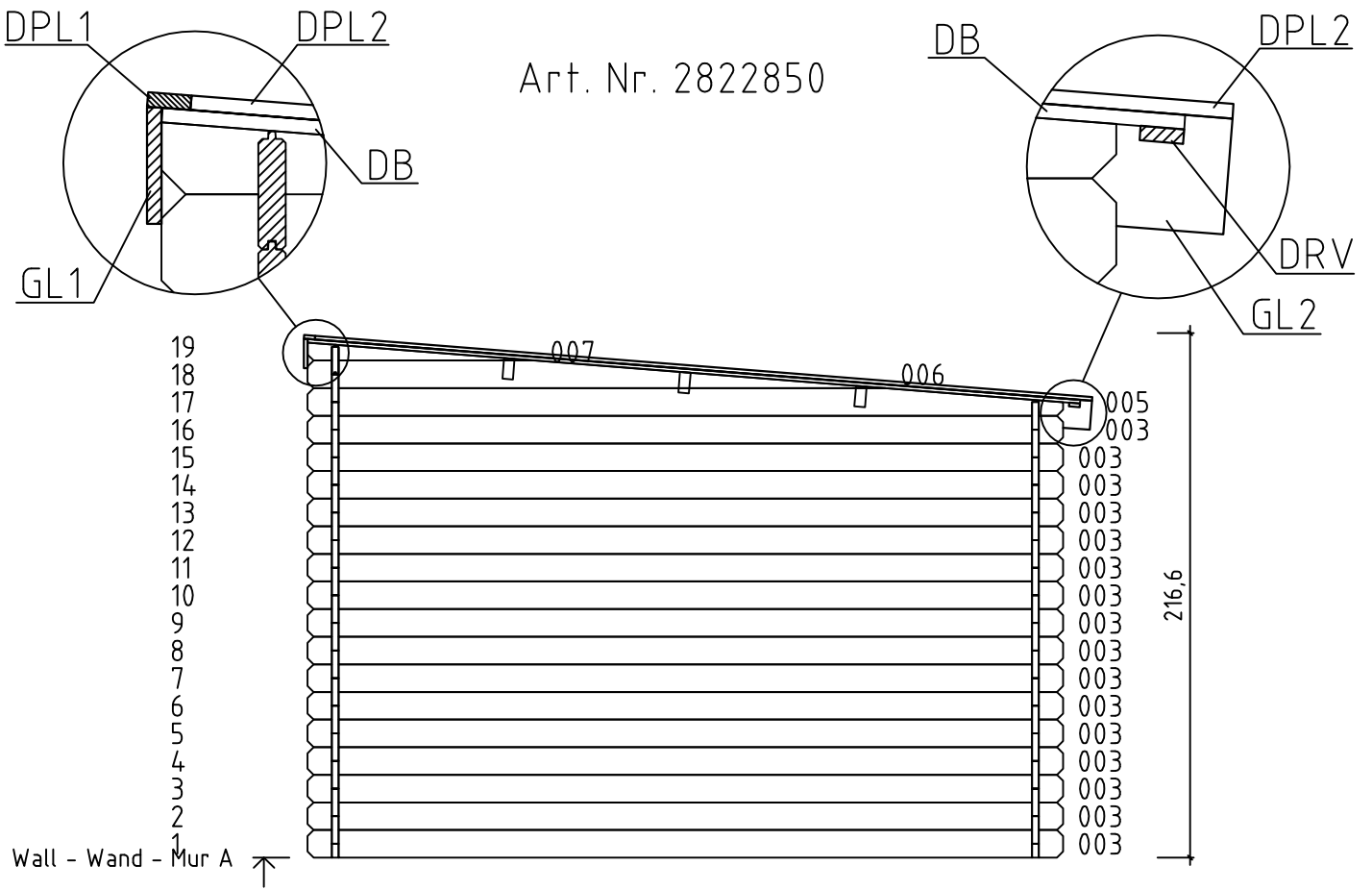

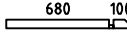
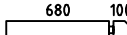
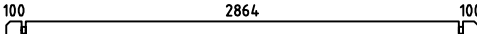
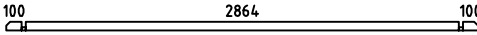
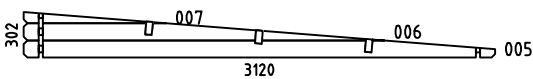
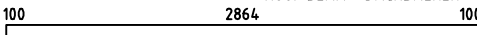



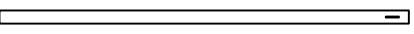
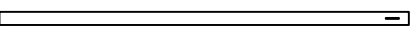
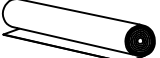
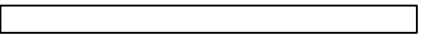
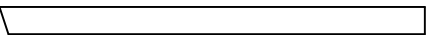
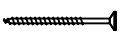

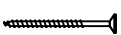
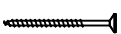

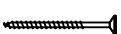

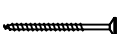
Art. Nr. 2822850

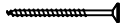
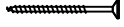

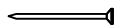
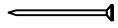

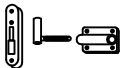
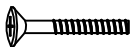
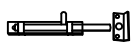

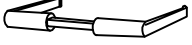
Art. Nr. 2822850

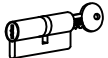
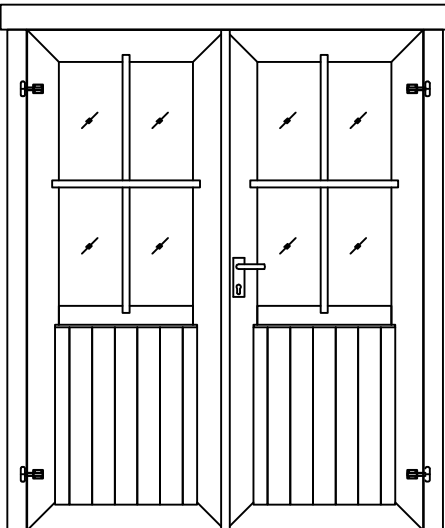

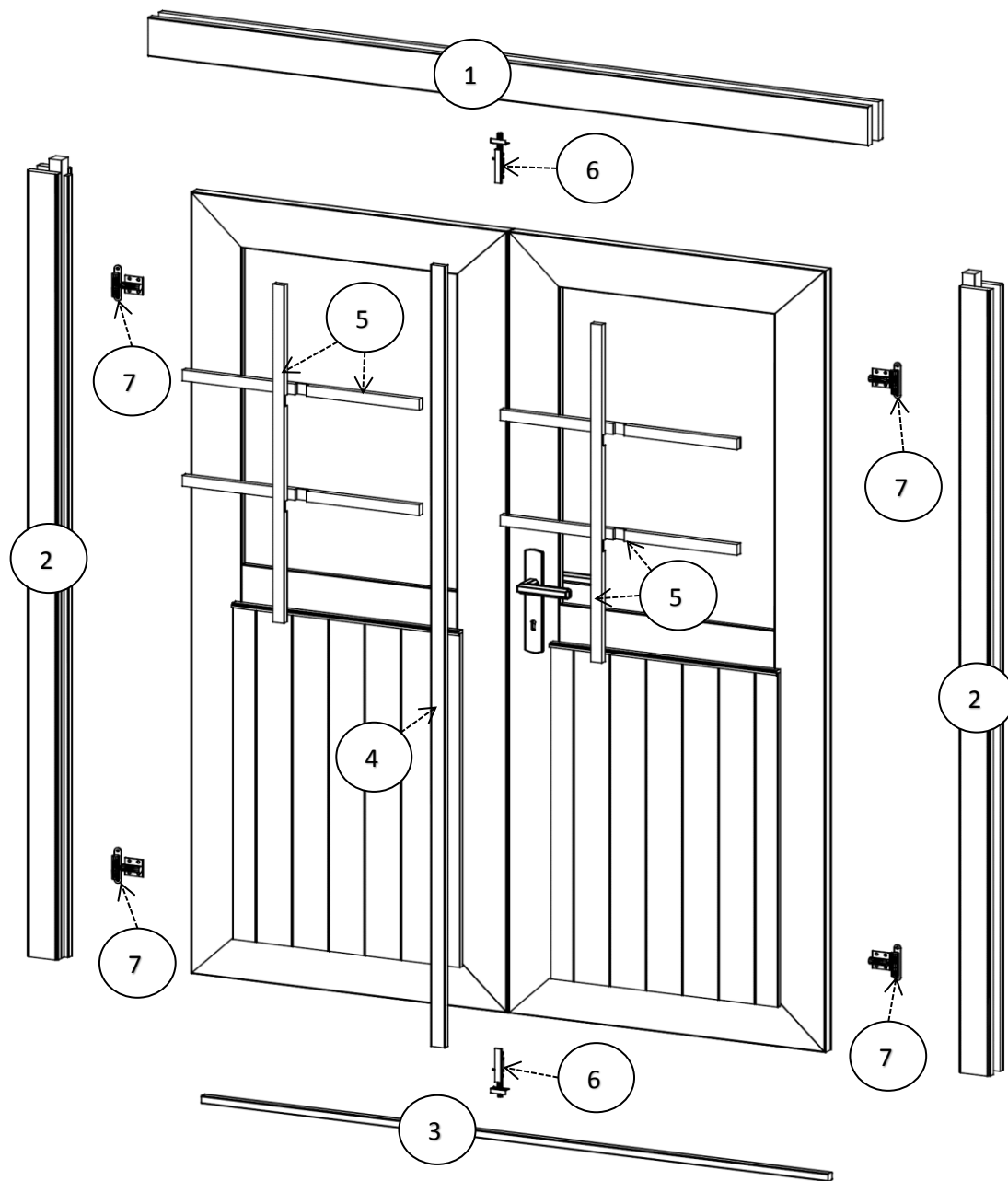
Pos	03.06.2015	Piecelist - Stücklist - Liste des composants Art. Nr. 2822850	5/6	Q.	P. (mm)	L. (mm)
001				2	28x57	808
002				32	28x114	808
003				50	28x114	3120
004				1	28x57	3120
WA-1 WB-1				1 1		
A-PR1		ROOF BEAM - DACHBALKEN - PANNE DE TOIT		3	44x95	3120
DB	ROOF BOARDS - DACHBRETTER - VOLIGES			35	90x15	3200
DPL1	ROOFING FELT FILLET - DACHPAPPENLEISTE - BAGUETTE DE FIXATION DU FEUTRE BITUMEUX			1	15x45	3150
DPL2	ROOFING FELT FILLET - DACHPAPPENLEISTE - BAGUETTE DE FIXATION DU FEUTRE BITUMEUX			2	15x45	3220
DRV	ROOF EDGE REINFORCEMENT - DACHRANDVERSTÄRKUNG - CORNIERE DE RENFORT DE BORD DE TOIT			1	15x45	3120
	STORM PROTECTION - STURMLEISTE - - LATTE ANTI-TEMPETE			2	22x45	1800
	STORM PROTECTION - STURMLEISTE - - LATTE ANTI-TEMPETE			2	22x45	2000
	ROOFING FELT (STRIP) - DACHPAPPE (BAHNEN) - FEUTRE BITUMEUX (BANDE)			4		3220
GL1	GABLE MOULDING - GIEBELLEISTE - - PLANCHE DE RIVE			1	15x120	3150
GL2	GABLE MOULDING - GIEBELLEISTE - - PLANCHE DE RIVE			2	15x120	3250
	SCREW FOR GEORGIAN BARS - SCHRAUBE FÜR SPROSSEN - VIS DE BARRES GEORGIENNE			8	2.5x20	
	SCREW FOR FIXING DOOR TO THE WALL - SCHRAUBE ZUR BEFESTIGUNG TÜR - ZARGE MIT WAND - VIS DE FIXATION DORMANT DE PORTE			2	3.5x50	
	SCREW FOR GABLE MOULDING - SCHRAUBEN FÜR GIEBELLEISTE - VIS DE FIXATION POUR PLANCHE DE RIVE			28	3.5x50	
	SCREW FOR DOORSTEP - SCHRAUBEN FÜR SWELLE - VIS DE FIXATION DU SEUIL DE PORTE			3	3x30	
	SCREW FOR ROOF EDGE REINFORCEMENT - SCHRAUBEN FÜR DACHRANDVERSTÄRKUNG - VIS POUR RENFORT DE BORD DE TOIT			7	3x30	
	SCREW FOR DOOR FILLET - SCHRAUBE ZUR BEFESTIGUNG TÜRLEISTE - VIS D'ASSEMBLAGE DU CADRE DE PORTE			5	3x30	
	SCREW FOR FIXING BOLT HINGE - SCHRAUBE FÜR TÜRRIHEL - VIS DE FIXATION POUR CHARNIERES ET GONDS DE PORTE			16	4x30	
	SCREW FOR FIXING BOLT HINGE - SCHRAUBE FÜR TÜRRIHEL - VIS DE FIXATION POUR CHARNIERES ET GONDS DE PORTE			12	4x40	
	SCREW FOR DOOR JAMB - SCHRAUBE FÜR TÜRRAHMEN - VIS DE FIXATION POUR MONTANT DE PORTE			2	4x60	

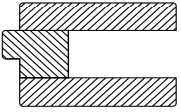
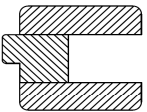
Pos	03.06.2015	Piecelist - Stücklist - Liste des composants Art. Nr. 2822850	6/6	Q.	P. (mm)	L. (mm)
		SCREW FOR ROOF BEAMS - SCHRAUBEN FÜR DACHBALKEN - VIS POUR PANNE DE TOIT		10	5x120	
		SCREW FOR DOOR JAMB - SCHRAUBE FÜR TÜRRAHMEN - VIS DE FIXATION POUR MONTANT DE PORTE		2	5x90	
		HAMMER BLOCK - SCHLAGHOLZ - CALLE DE FRAPPE		1		
		NUT FOR STORM PROTECTION - SCHRAUBENMUTTER FÜR STURMLEISTE - ÉCROU POUR LAME ANTI-TEMPETE		8	D6	
		ZN NAIL FOR ROOF - ZN NÄGEL FÜR DACHBRETTER - POINTES DE FIXATIONS DES VOLIGES DE TOIT		188	2x50	
		ZN NAIL FOR ROOFING FELT FILLET - ZN NÄGEL FÜR DACHPAPPENLEISTE - POINTE POUR BAGUETTE FIXATION FEUTRE BITUMEUX		21	2x40	
		ROOFING NAILS FOR ROOFING FELT - NÄGEL FÜR DACHPAPPE - POINTE DE FIXATION POUR FEUTRE BITUMEUX		110	2.8x15	
		MALE BOLT HINGE FOR DOOR - TÜRRIEGEL - PARTIE MALE DE CHARNIERE DE PORTE		4	DIN15-57	
		BOLT FOR STORM PROTECTION - BOLZEN FÜR STURMLEISTE - VIS POUR LAME ANTI-TEMPETE		8	6x60	
		LATCH BOLT FOR DOUBLE DOOR - TORRIEGEL - LOQUET POUR DOUBLE PORTE		2		90
		WASHER FOR STORM PROTECTION - DICHTSCHEIBE FÜR STURMLEISTE - RONDELLE POUR LAME ANTI-TEMPETE		8	D6	
		DOOR HANDLE FITTINGS - TÜRRGRIFF - SET DE GARNITURES DE SERRURE DE PORTE		1		
		SET OF DOOR LOCK COVERS - SCHLOSSBLENDEN - SET DE GARNITURES DE SERRURE DE PORTE		1		
		CYLINDER LOCK - ZYLINDERSCHLOSS - CYLINDRE DE SERRURE		1	30/30	
		DOOR - TÜR - PORTE 1494x1850 XGA+28 TUK.2.044.XVP.MX28 Plexiglass - Plexiglas - Plexiglas		1		

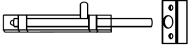
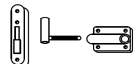

Pos	Piece list - Stückliste - Liste des pièces	Q.	P (mm)
1		1	66x100
2		2	66x80
3		1	18x18
4		1	13x32
5		6	15x25
6		2	
7		4	

