

**Art.nr. 2810650**

**1/5**

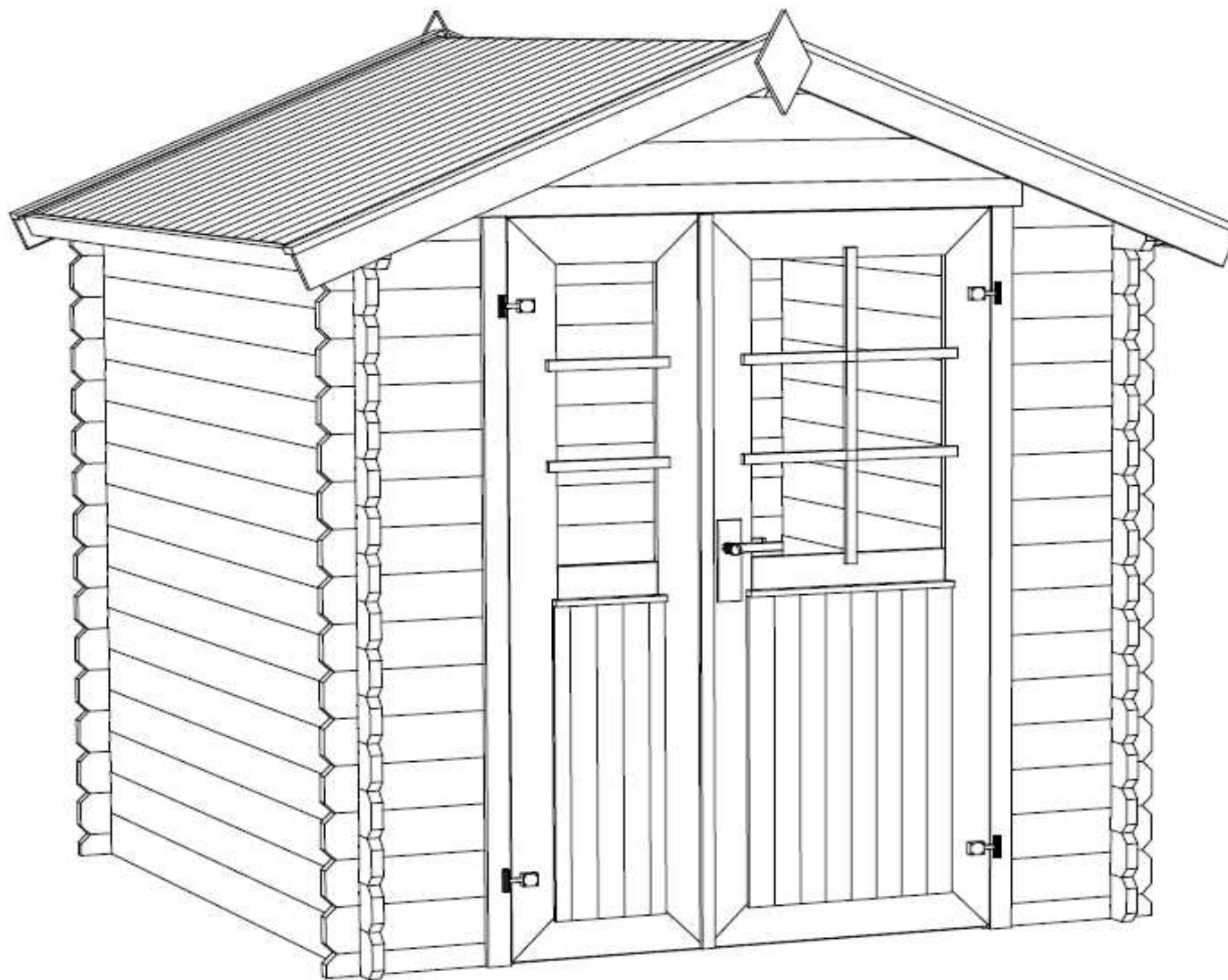





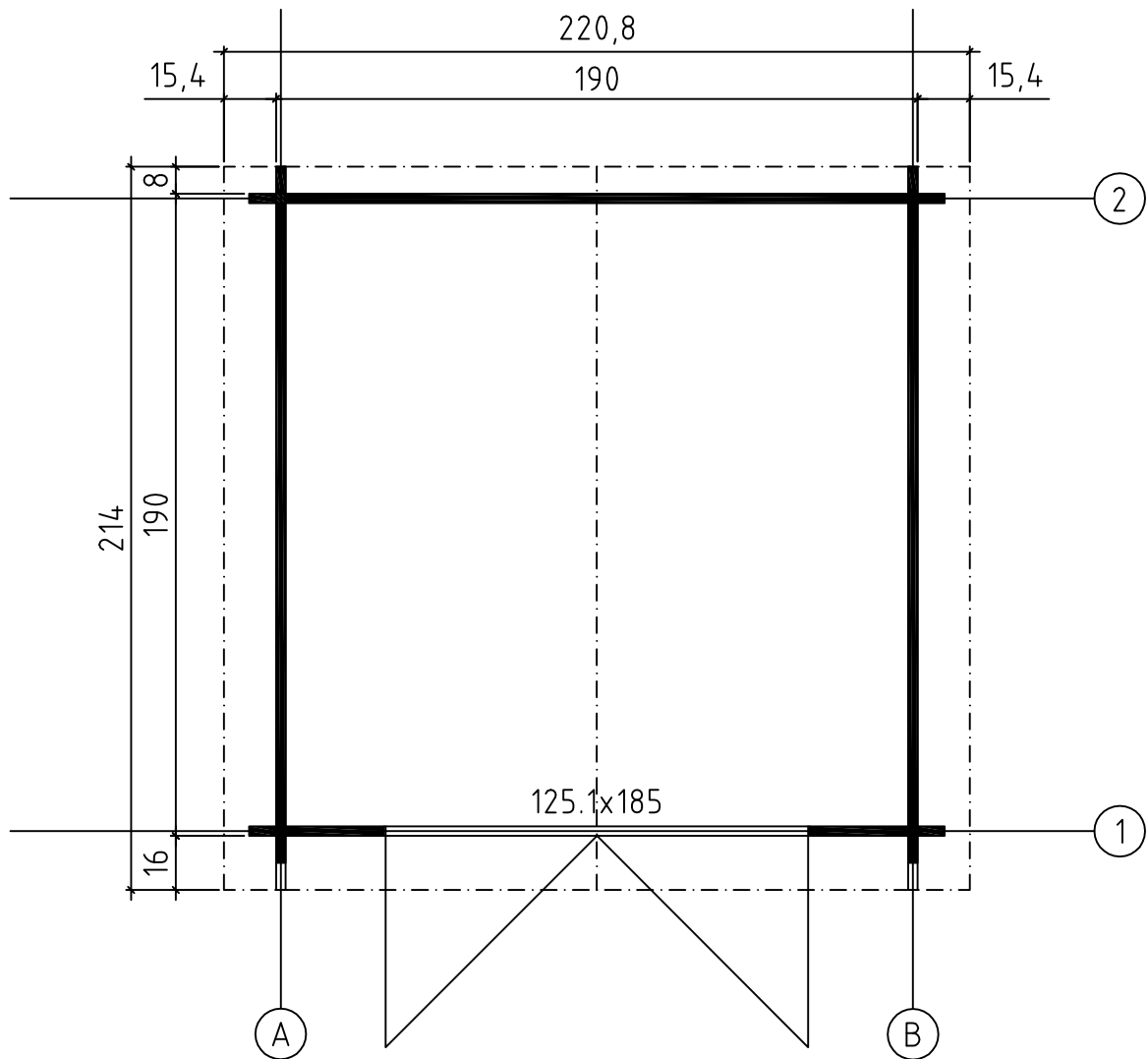



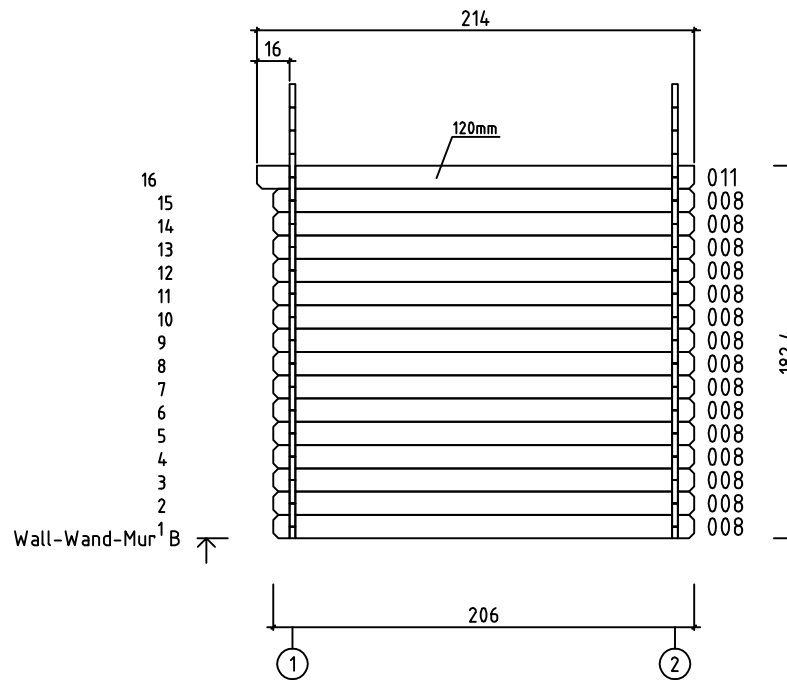
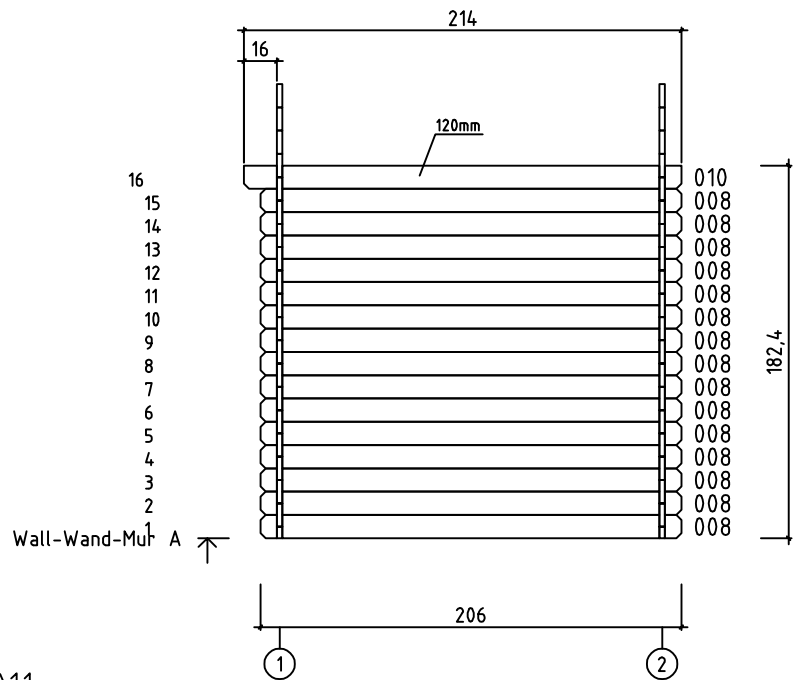
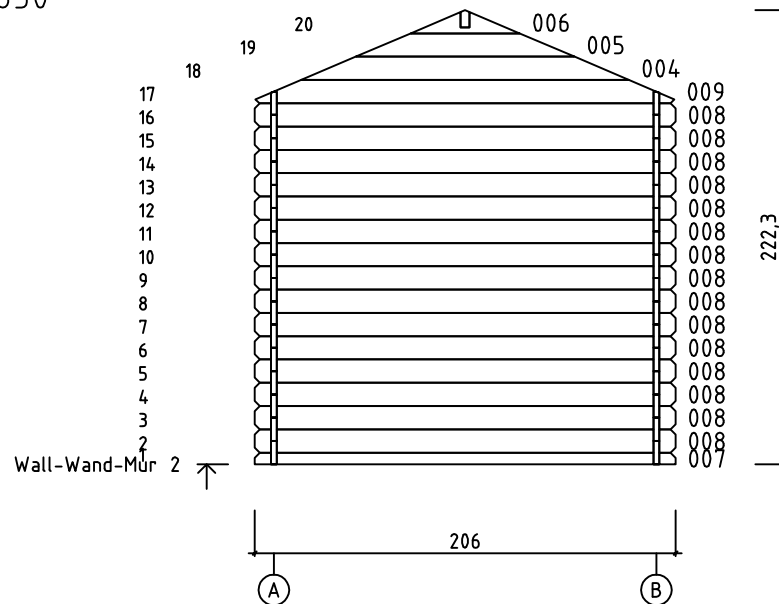
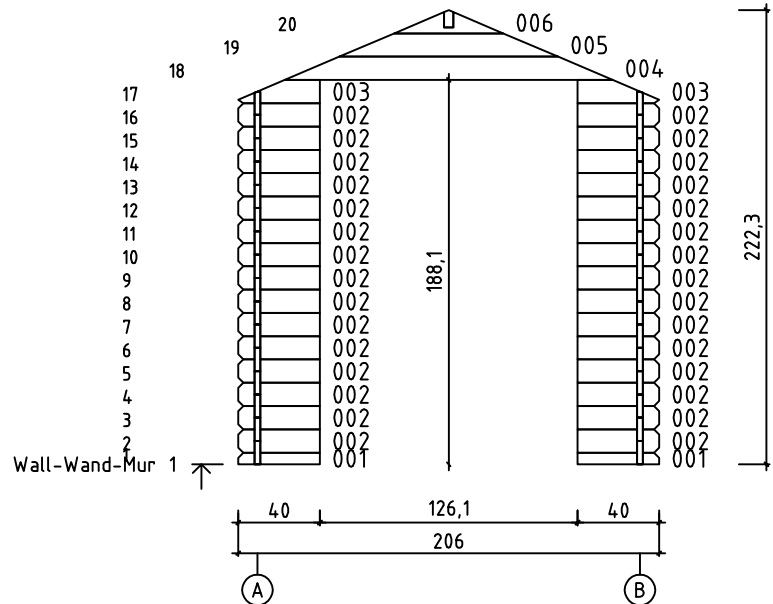



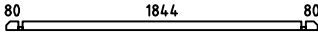
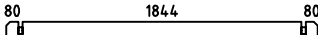
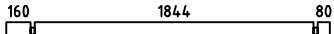
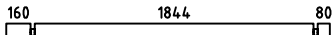
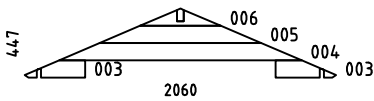
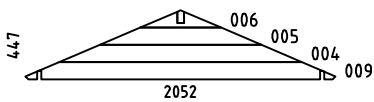
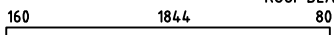
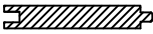

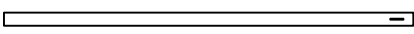
Art.Nr. 2810650

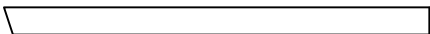

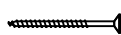
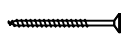

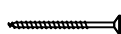



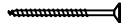

GROUNDPLAN - GRUNDPLAN - PLAN DE MASSE

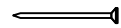

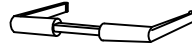
Art.Nr. 2810650

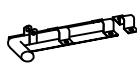

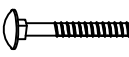
| Pos  | 30.06.2011   | Piecelist - Stücklist - Liste des composants<br>Art.Nr. 2810650                       | 4/5 | Q. | P.<br>(mm) | L.<br>(mm) |
|------|--|---|-----|----|------------|------------|
| 001  |                                       |   |     | 2  | 28x57      | 400        |
| 002  |                                       |   |     | 30 | 28x114     | 400        |
| 007  |                                       |   |     | 1  | 28x57      | 2060       |
| 008  |                                       |   |     | 45 | 28x114     | 2060       |
| 010  |                                       |   |     | 1  | 28x120     | 2140       |
| 011  |                                       |   |     | 1  | 28x120     | 2140       |
| W1-1 |                                       |   |     | 1  |            |            |
| W2-1 |                                       |   |     | 1  |            |            |
| PR1  |                                      | ROOF BEAM - DACHBALKEN - PANNE DE TOIT  |     | 1  | 44x120     | 2140       |
|      | ROOF BOARDS - DACHBRETTER - VOLIGES  |  |     | 48 | 90x15      | 1200       |
|      | ROOFING FELT FILLET - DACHPAPPENLEISTE - BAGUETTE DE FIXATION<br>DU FEUTRE BITUMEUX                                    |  |     | 4  | 18x58      | 1250       |
|      | EAVES BOARD - TRAUFBRETT - BANDEAU DE TOIT   |  |     | 2  | 18x58      | 2140       |
|      | STORM PROTECTION - STURMLEISTE -<br>LATTE ANTI-TEMPETE   |   |     | 4  | 22x45      | 1760       |
|      | ROOFING FELT - DACHPAPPE - FEUTRE BITUMEUX   |  |     | 3  |            | 2240       |
|      | GABLE MOULDING - GIEBELLEISTE -<br>- PLANCHE DE RIVE   |   |     | 4  | 18x120     | 1250       |
| HS57 | SCREW FOR DOOR LOCK - SCHRAUBEN FÜR TÜRSCHLOSS - VIS POUR<br>SERRURE DE PORTE  |  |     | 2  | 2.5x25     |            |
|      | SCREW FOR GABLE SEGMENT - SCHRAUBEN FÜR DECKBLATT - VIS<br>POUR FIXATION LOSANGE DE FINITION                           |  |     | 4  | 3.5x35     |            |
| HS22 | SCREW FOR FIXING DOOR TO THE WALL - SCHRAUBE ZUR BEFESTIGUNG<br>TÜR- ZARGE MIT WAND - VIS DE FIXATION DORMANT DE PORTE |  |     | 2  | 3.5x50     |            |
| HS59 | SCREW FOR DOORSTEP - SCHRAUBEN FÜR SWELLE - VIS DE FIXATION<br>DU SEUIL DE PORTE                                       |  |     | 3  | 3x30       |            |
|      | SCREW FOR FILLET - SCHRAUBE ZUR BEFESTIGUNG TÜRLEISTE -<br>- VIS D'ASSEMBLAGE DU CADRE DE PORTE                        |  |     | 5  | 3x30       |            |
|      | SCREW FOR FIXING BOLT HINGE - SCHRAUBE FÜR TÜRRIGEL -<br>- VIS DE FIXATION POUR CHARNIÈRES ET GONDS DE PORTE           |  |     | 16 | 4.5x25     |            |
|      | SCREW FOR FIXING BOLT HINGE - SCHRAUBE FÜR TÜRRIGEL -<br>- VIS DE FIXATION POUR CHARNIÈRES ET GONDS DE PORTE           |  |     | 12 | 4.5x35     |            |
|      | SCREW FOR DOOR JAMB - SCHRAUBE FÜR TÜRRAHMEN - VIS DE<br>FIXATION POUR MONTANT DE PORTE                                |  |     | 2  | 4x60       |            |

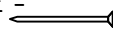
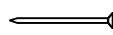
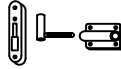
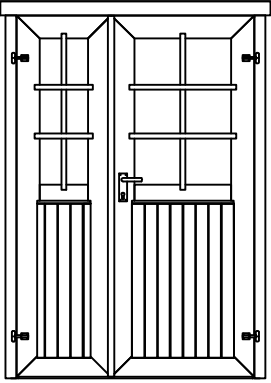
| Pos | 30.06.2011 | Piecelist - Stücklist - Liste des composants<br>Art.Nr. 2810650  | 5/5   | Q.  | P.<br>(mm) | L.<br>(mm) |
|-----|------------|--|---|-----|------------|------------|
|     |            | SCREW FOR DOOR JAMB - SCHRAUBE FÜR TÜRRAHMEN - VIS DE FIXATION POUR MONTANT DE PORTE                                 |    | 2   | 5x90       |            |
|     |            | HAMMER BLOCK - SCHLAGHOLZ - CALLE DE FRAPPE 28mm   |    | 1   |            |            |
|     |            | ROOFING NAILS FOR ROOFING FELT - NÄGEL FÜR DACHPAPPE -<br>- POINTE DE FIXATION POUR FEUTRE BITUMEUX                  |    | 64  | 2.1x17     |            |
|     |            | DOOR LOCK - TÜRSCHLOSS -SERRURE DE PORTE   |    | 1   |            |            |
|     |            | DOOR HANDLE FITTINGS - TÜRGRIF - GARNITURE DE POIGNÉE DE PORTE   |     | 1   |            |            |
|     |            | DOOR HANDLE FITTINGS - TÜRGRIF - SET DE GARNITURES DE SERRURE DE PORTE   |    | 1   |            |            |
|     |            | STICKER FOR LOCK -SCHLIEßBLECH FÜR TÜRSCHLOSS -GACHE DE PORTE  |    | 1   |            |            |
|     |            | SCREW FOR GABLE MOULDING - SCHRAUBEN FÜR GIEBELLEISTE -<br>- VIS DE FIXATION POUR PLANCHE DE RIVE                    |   | 16  | 3.5x50     |            |
|     |            | SCREW FOR EAVES BOARDS - SCHRAUBEN FÜR TRAUFBRETT -<br>- VIS DE FIXATION POUR BANDEAU DE TOIT                        |   | 10  | 4x40       |            |
|     |            | LATCH BOLT FÜR DOUBLE DOOR - TORRIEGEL - LOQUET POUR DOUBLE PORTE  |    | 2   |            |            |
|     |            | GABLE SEGMENT - DECKBLATT - LOSANGE DE FINITION  |   | 2   |            |            |
|     |            | NUT FOR STORM PROTECTION - SCHRAUBENMUTTER FÜR STURMLEISTE -<br>- ÉCROU POUR LAME ANTI-TEMPETE                       |  | 8   |            |            |
|     |            | BOLT FOR STORM PROTECTION - BOLZEN FÜR STURMLEISTE -<br>- VIS POUR LAME ANTI-TEMPETE                                 |  | 8   |            |            |
|     |            | WASHER FOR STORM PROTECTION - DICHTSCHEIBE FÜR STURMLEISTE -<br>- RONDELLE POUR LAME ANTI-TEMPETE                    |  | 8   |            |            |
|     |            | ZN NAIL FOR ROOFING FELT FILLET - ZN NÄGEL FÜR DACHPAPPENLEISTE -<br>- POINTE POUR BAGUETTE FIXATION FEUTRE BITUMEUX |  | 16  |            |            |
|     |            | ZN NAIL FOR ROOF - ZN NÄGEL FÜR DACHBRETT - POINTE POUR TOIT   |  | 104 |            |            |
|     |            | MALE BOLT HINGE FOR DOOR - TÜRRIEGEL - PARTIE MALE DE CHARNIERE DE PORTE   |  | 4   |            |            |
|     |            | DOOR - TÜR - PORTE 1251x1850   |   | 1   |            |            |
|     |            |                                   |   |     |            |            |
|     |            | TUK.2.056.SVP.M28b   |   |     |            |            |

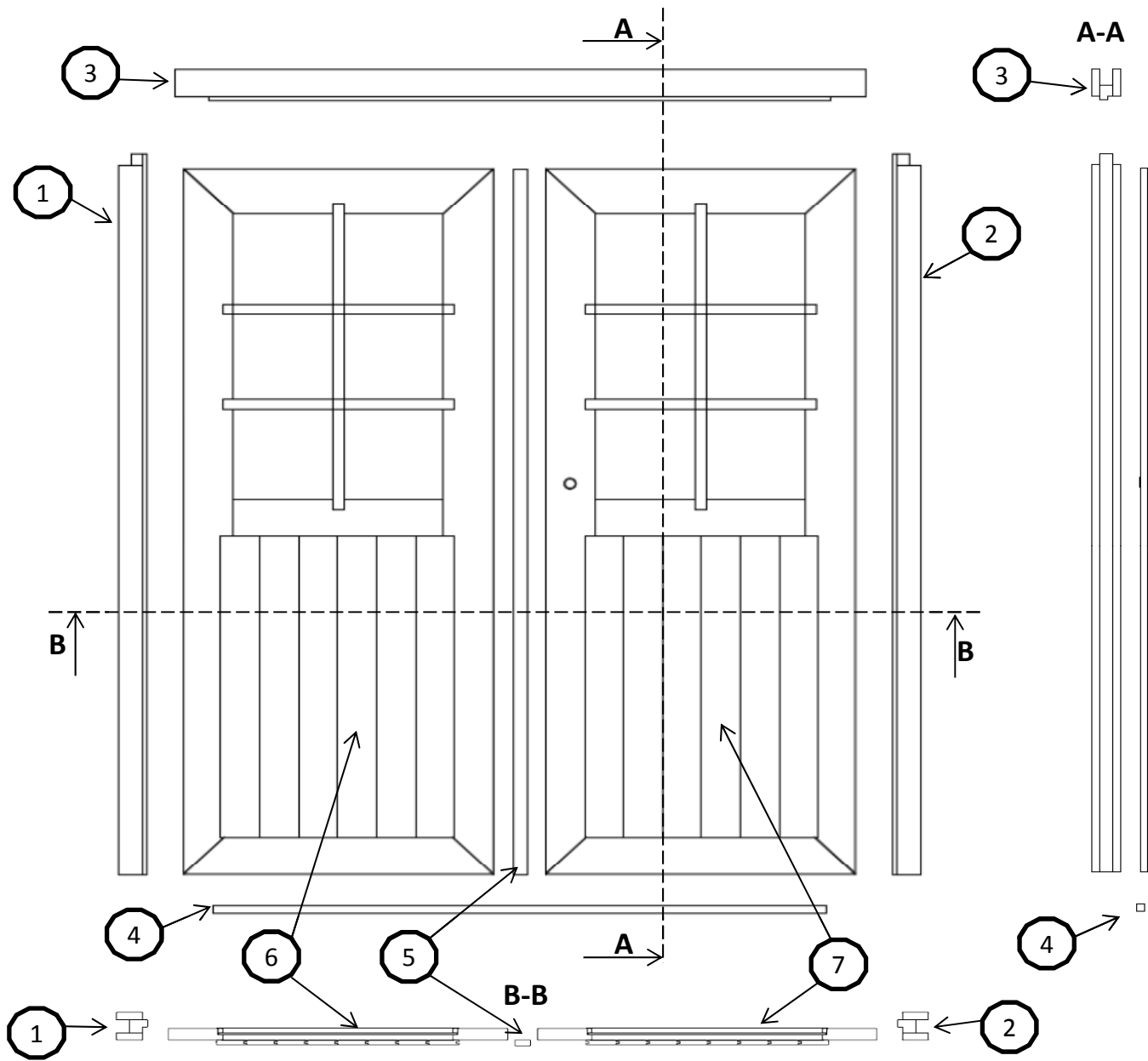

| Pos. | Q. | Dimensions   |
|------|----|--------------|
| 1    | 1  | 65 mm, 66 mm |
| 2    | 1  | 65 mm, 66 mm |
| 3    | 1  | 65 mm, 66 mm |
| 4    | 1  | 18 mm        |
| 5    | 1  | 18 mm, 31 mm |
| 6    | 1  | 716 mm       |
| 7    | 1  | 716 mm       |

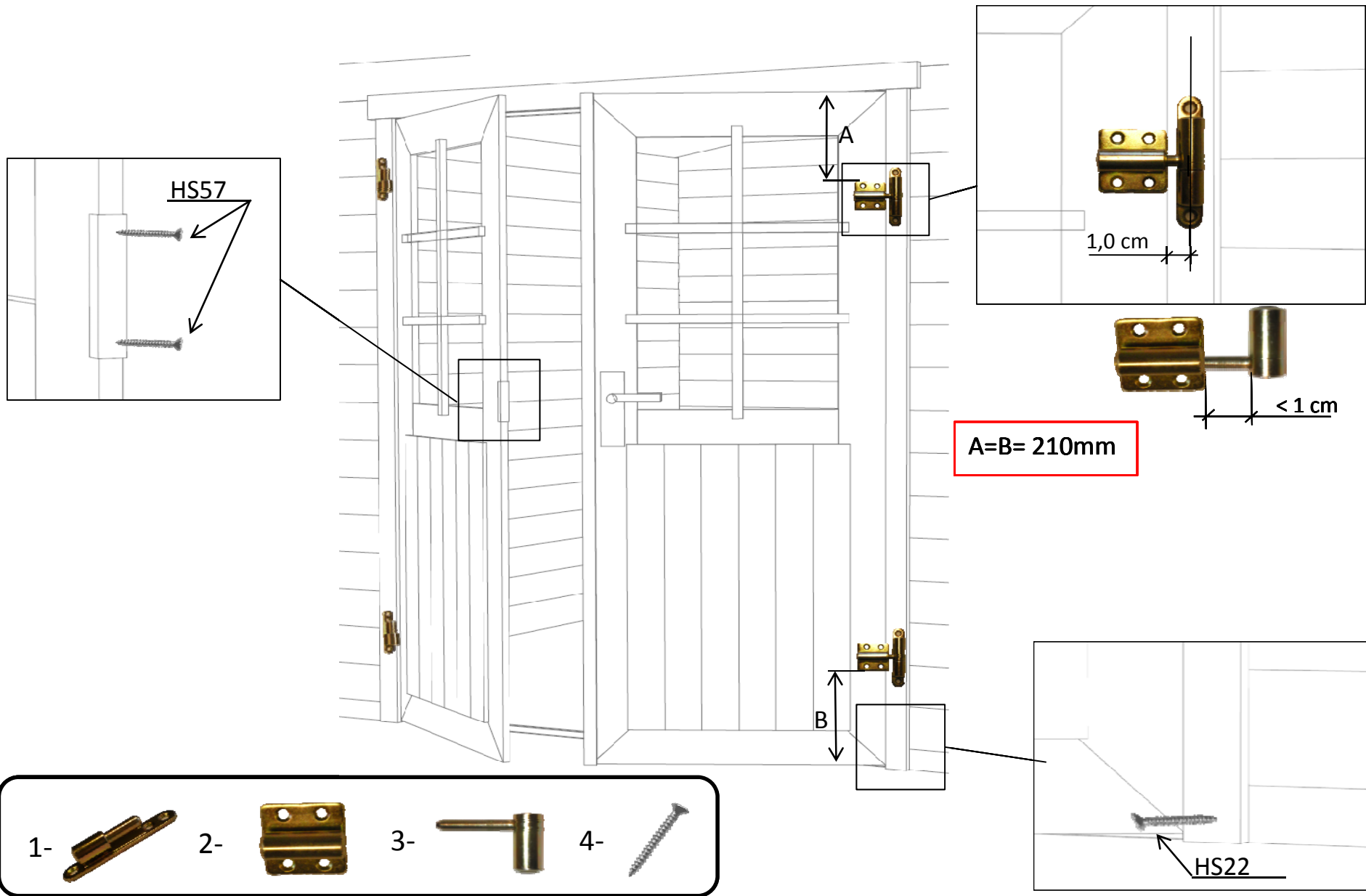

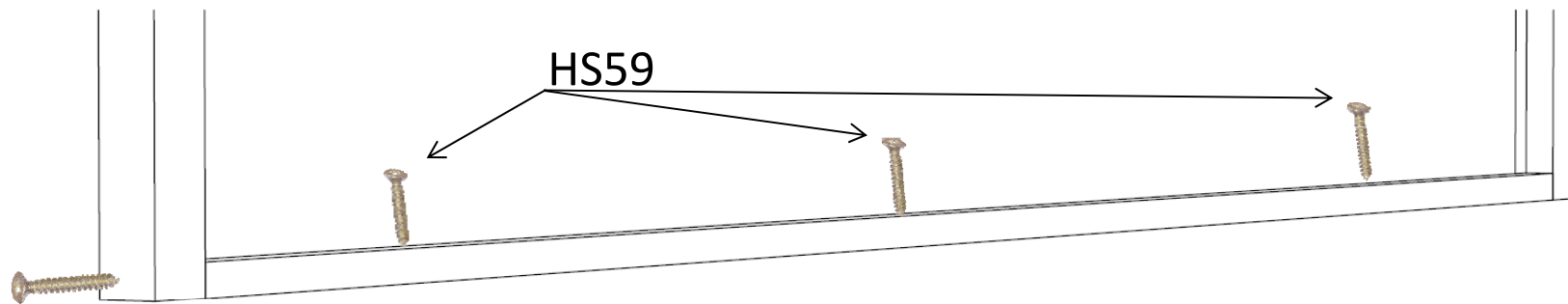

HS59

4,0x60mm

