

Orkney
Art. Nr. 4413802
1/10

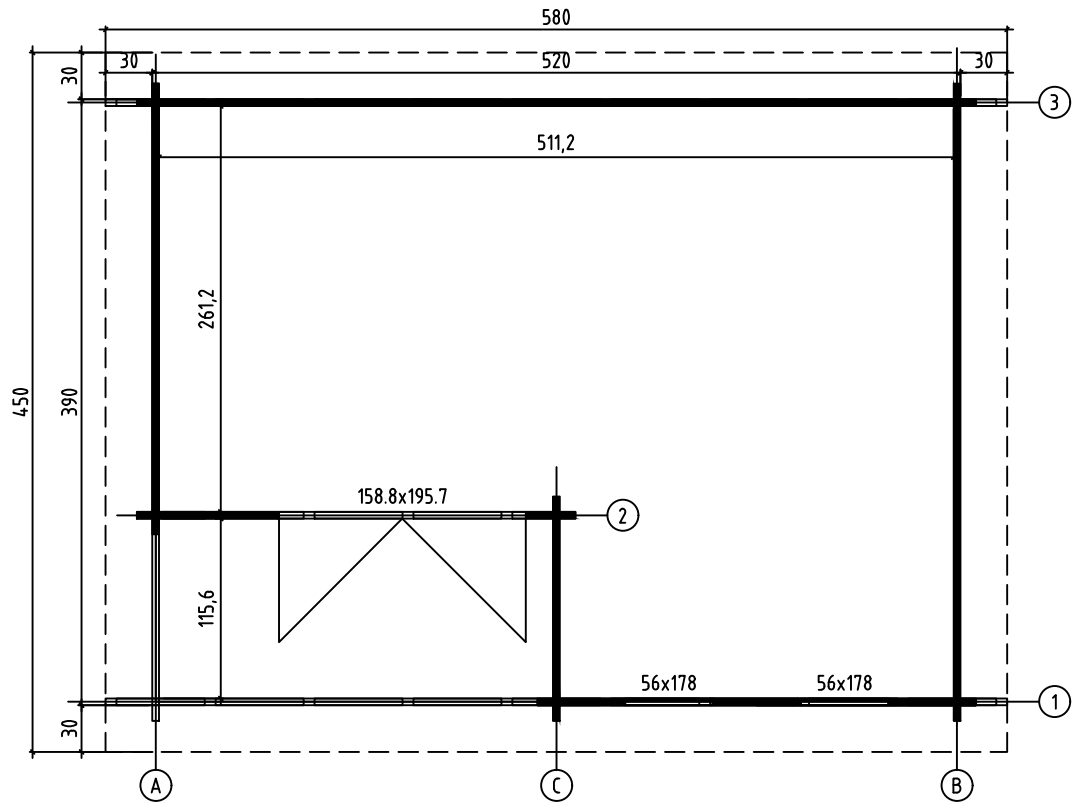

13.03.2017

Art.Nr. 4413802
 GROUNDPLAN - GRUNDPLAN - PLAN DE MASSE



FOUNDATION - FUNDAMENT - FONDATION

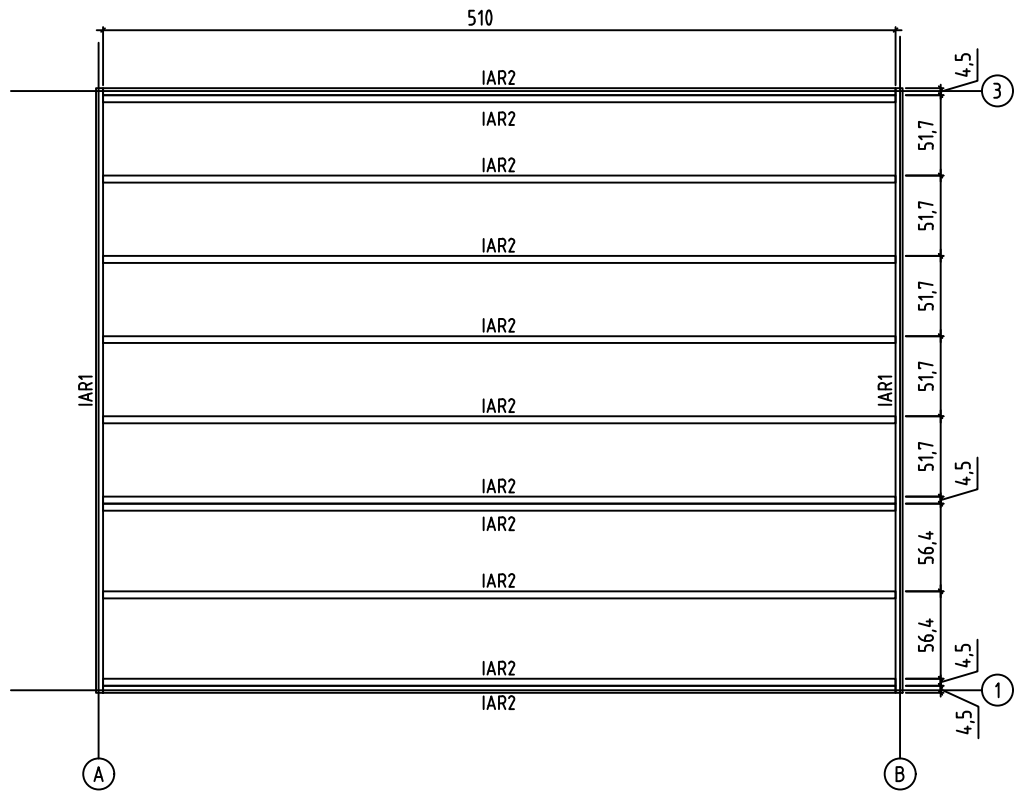

FLOOR BOARDS - FUSSBODENBRETTER - LAME DE PLANCHER
TERRACE BOARDS - TERRASSENBRETTER - PLANCHER DE TERRASSE

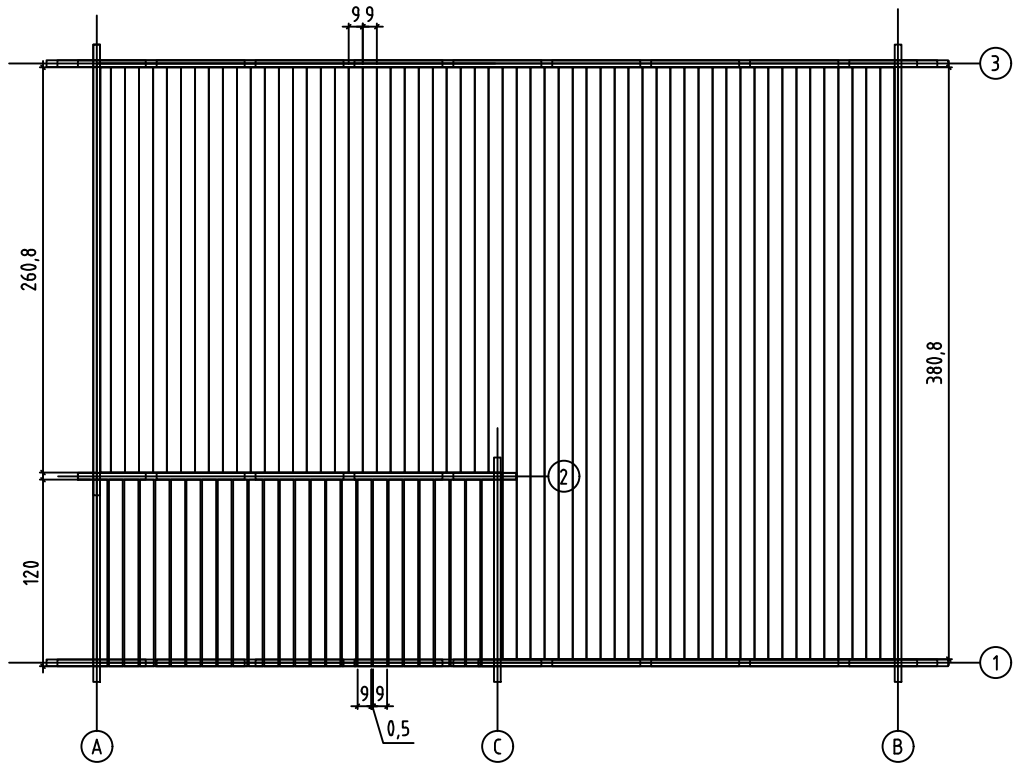

RAFTERS PLAN - DACHSPARREN - PLAN DE CHEVRON



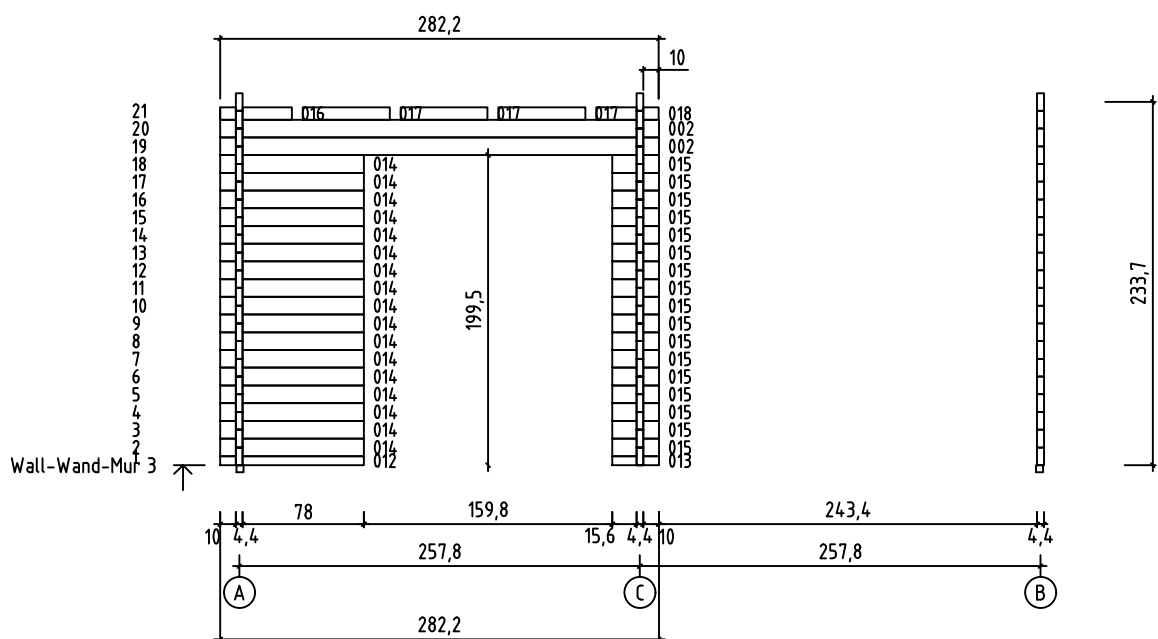
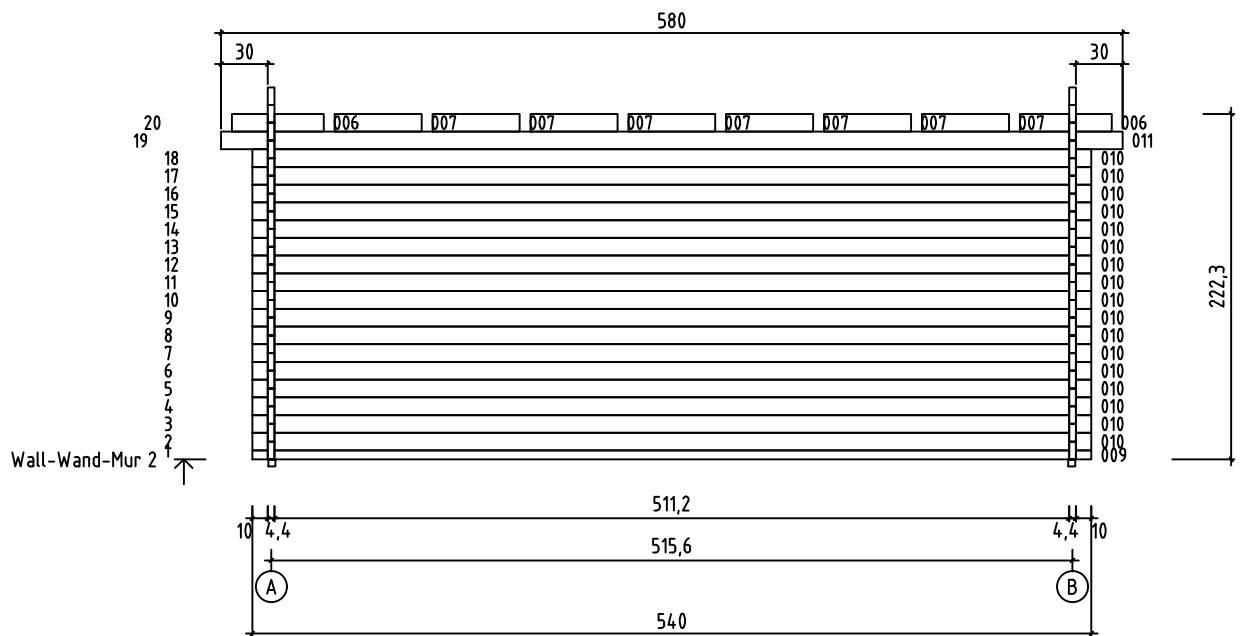
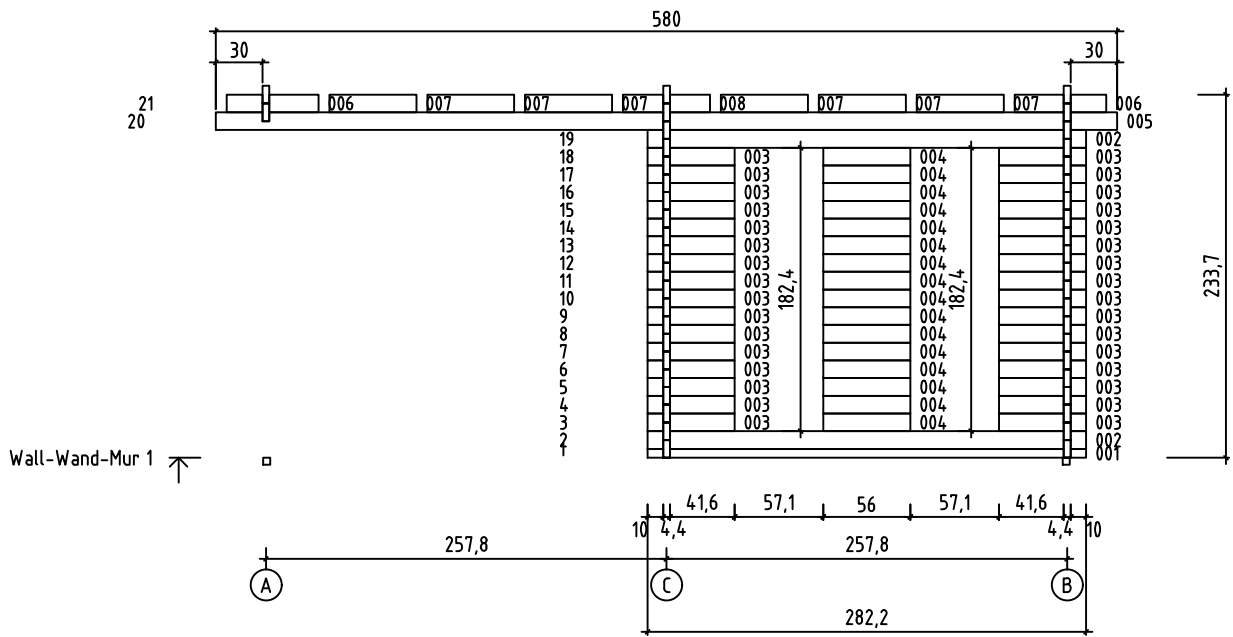

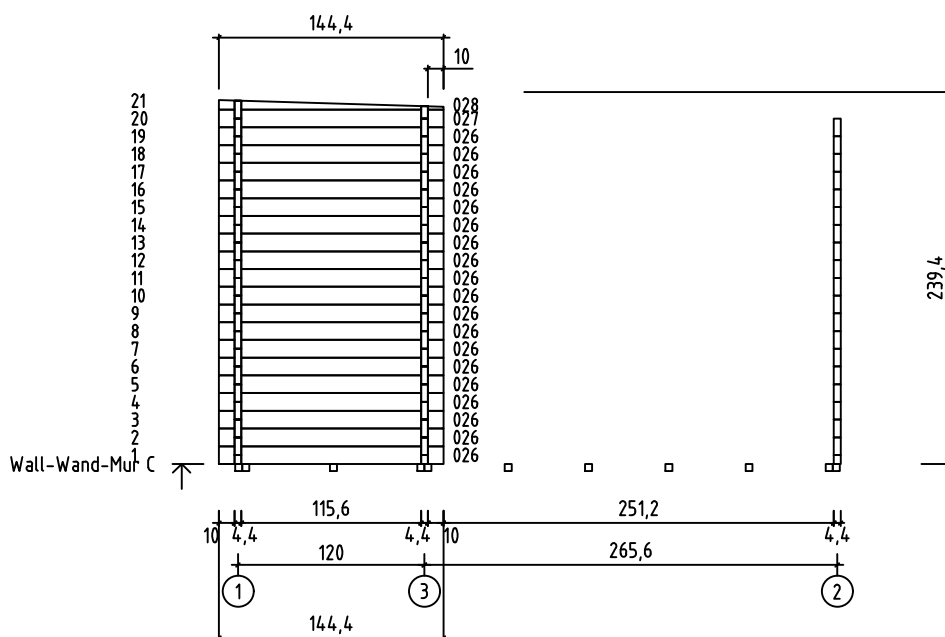
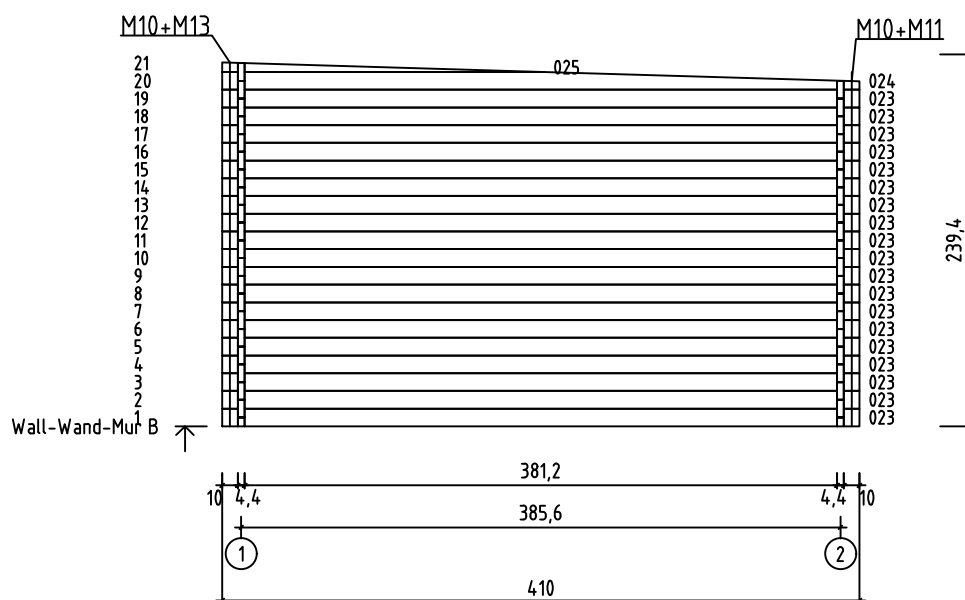
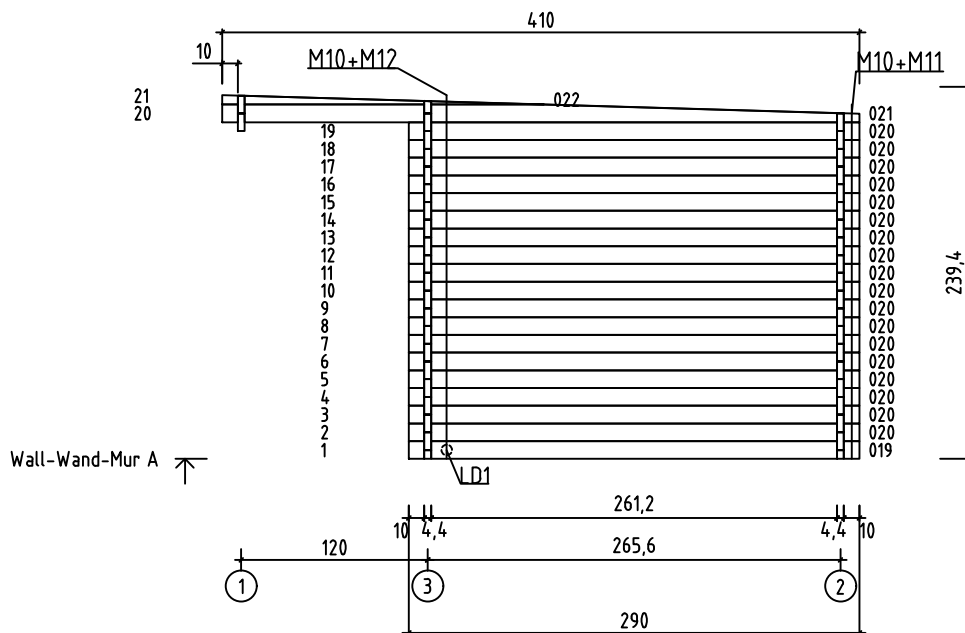

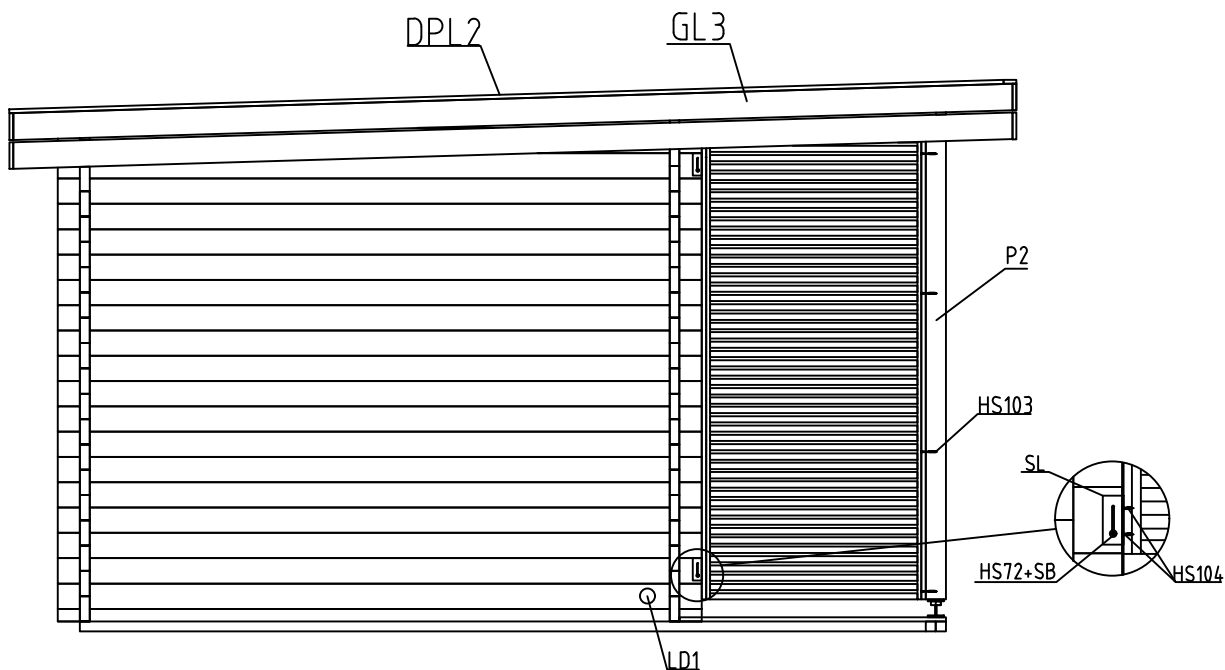
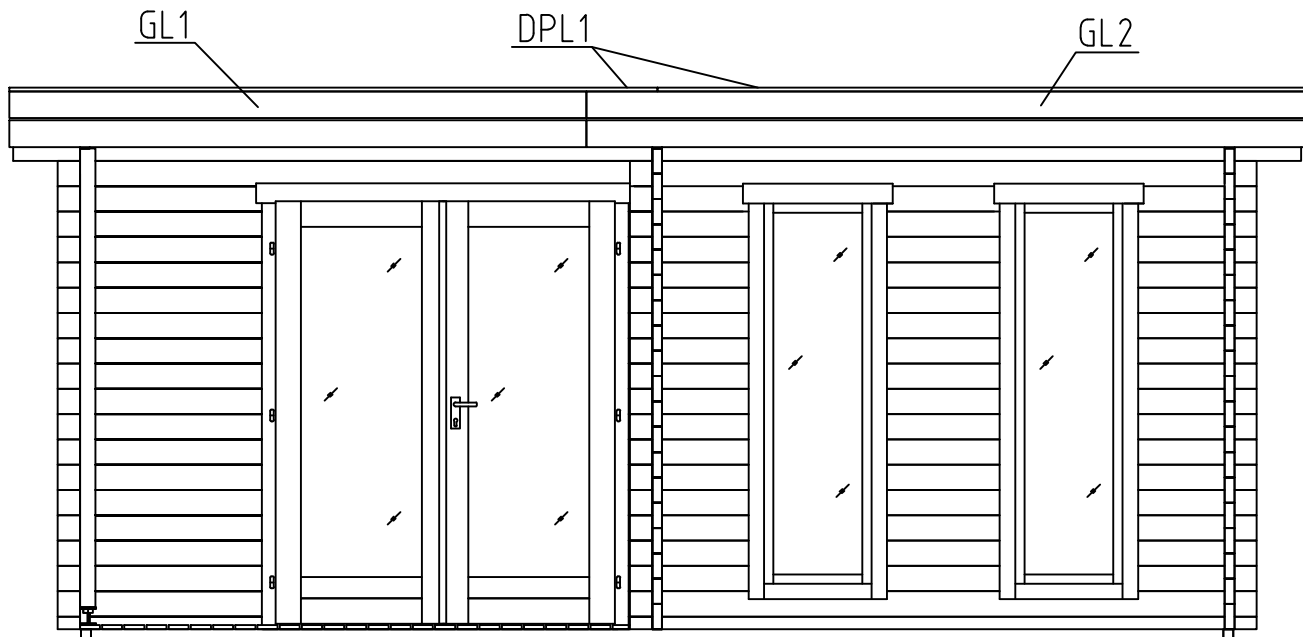



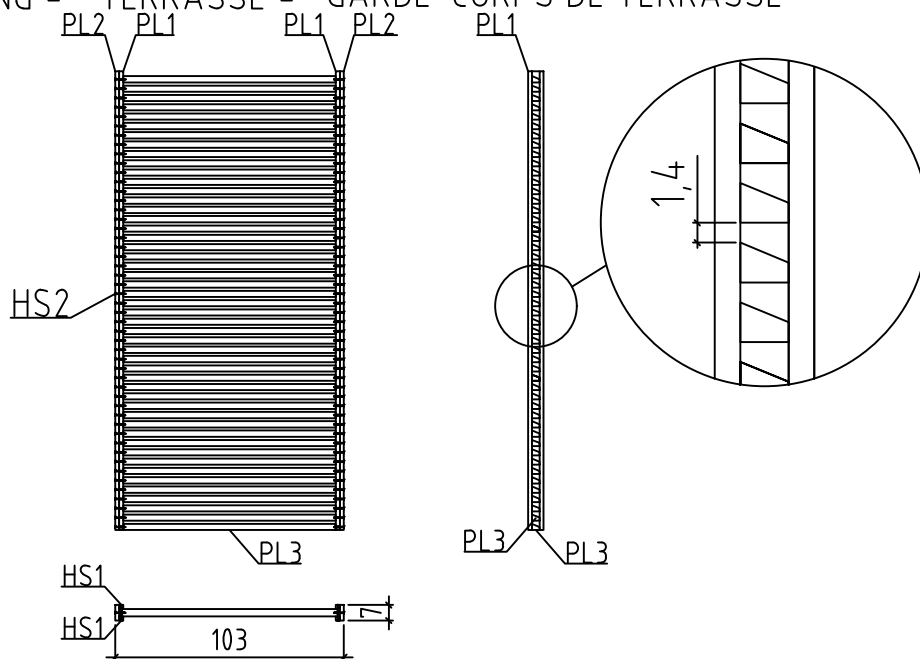

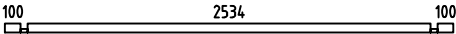
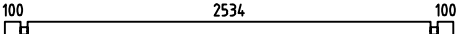

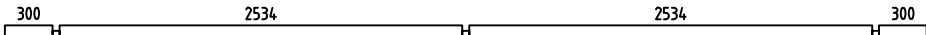



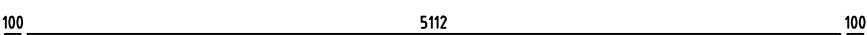
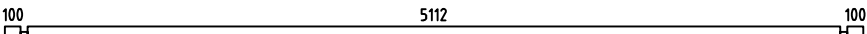
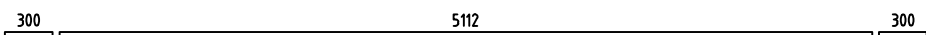
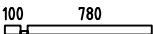

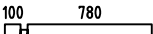



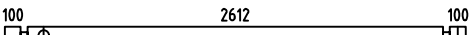
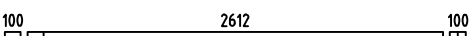
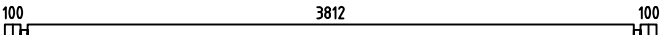
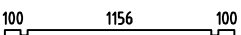
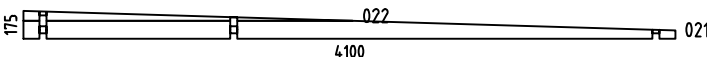
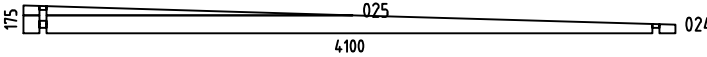
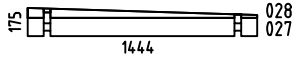



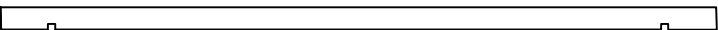
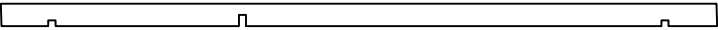



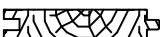
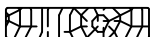

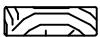





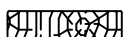

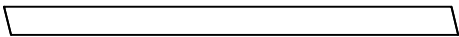
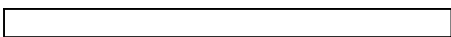
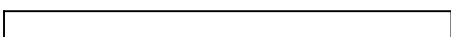







TERRACE RAILING - TERRASSE - GARDE-CORPS DE TERRASSE

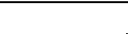
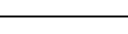
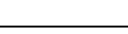

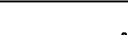
| Pos | 13.03.2017 | Piece list - Stückliste - Liste des pièces Art.Nr. 4413802 | 7/10 | Q. | P (mm) | L (mm) |
|------|------------|--------------------------------------------------------------------------------------|------|----|-----------|-----------|
| 001 | |  | | 1 | 44x57 | 2822 |
| 002 | |  | | 4 | 44x114 | 2822 |
| 003 | |  | | 32 | 44x114 | 560 |
| 004 | |  | | 16 | 44x114 | 560 |
| 005 | |  | | 1 | 44x114 | 5800 |
| 006 | |  | | 4 | 44x114 | 590 |
| 007 | |  | | 13 | 44x114 | 560 |
| 008 | |  | | 1 | 44x114 | 560 |
| 009 | |  | | 1 | 44x57 | 5400 |
| 010 | |  | | 17 | 44x114 | 5400 |
| 011 | |  | | 1 | 44x114 | 5800 |
| 012 | |  | | 1 | 44x57 | 924 |
| 013 | |  | | 1 | 44x57 | 300 |
| 014 | |  | | 17 | 44x114 | 924 |
| 015 | |  | | 17 | 44x114 | 300 |
| 016 | □ |  | | 1 | 44x80 | 460 |
| 017 | □ |  | | 3 | 44x80 | 560 |
| 018 | □ |  | | 1 | 44x80 | 402 |
| 019 | |  | | 1 | 44x114 | 2900 |
| 020 | |  | | 18 | 44x114 | 2900 |
| 023 | |  | | 19 | 44x114 | 4100 |
| 026 | |  | | 19 | 44x114 | 1444 |
| WA-1 | |  | | 1 | | |
| WB-1 | |  | | 1 | | |
| WC-1 | |  | | 1 | | |

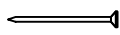
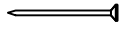
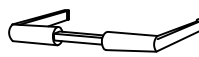
| Pos | 13.03.2017 | Piece list - Stückliste - Liste des pièces Art.Nr. 4413802 | 8/10 | Q. | P (mm) | L (mm) |
|------|------------|--------------------------------------------------------------------------------------------------------------------------------------------------------------------------------------------------------|------|----|-----------|-----------|
| IAR2 | | FOUNDATION - FUNDAMENT - FONDATION  | | 11 | 45x45 | 5100 |
| IAR1 | | FOUNDATION - FUNDAMENT - FONDATION  | | 2 | 45x45 | 3890 |
| SR1 | | RAFTER - DACHSPARREN - CHEVRON  | | 6 | 70x140 | 4506 |
| SR2 | | RAFTER - DACHSPARREN - CHEVRON  | | 4 | 70x140 | 4506 |
| | | FLOOR BOARDS - FUSSBODENBRETTER - LAME DE PLANCHER  | | 29 | 90x18 | 3808 |
| | | FLOOR BOARDS - FUSSBODENBRETTER - LAME DE PLANCHER  | | 28 | 90x18 | 2608 |
| DB2 | | ROOF BOARDS - DACHBRETTER - VOLIGES  | | 51 | 90x18 | 3845 |
| DB1 | | ROOF BOARDS - DACHBRETTER - VOLIGES  | | 51 | 90x18 | 1955 |
| SV | | TERRACE BOARDS - TERRASSENBRETTER - PLANCHER DE TERRASSE  | | 28 | 90x19 | 1200 |
| FL | | FLOOR FILLET-FUSSBODENLEISTE - CORNIERE DE FINITION DU PLANCHER  | | | 18x18 | 17.83 |
| DPL1 | | ROOFING FELT FILLET - DACHPAPPENLEISTE - BAGUETTE DE FIXATION DU FEUTRE BITUMEUX  | | 2 | 18x58 | 2860 |
| DPL2 | | ROOFING FELT FILLET - DACHPAPPENLEISTE - BAGUETTE DE FIXATION DU FEUTRE BITUMEUX  | | 2 | 18x58 | 4542 |
| M11 | | TREADED ROD M10 - GEWINDESTANGE M10 - TIGE FILETÉE M10  | | 2 | | 250 |
| M12 | | TREADED ROD M10 - GEWINDESTANGE M10 - TIGE FILETÉE M10  | | 1 | | 270 |
| M13 | | TREADED ROD M10 - GEWINDESTANGE M10 - TIGE FILETÉE M10  | | 1 | | 370 |
| M10 | | TREADED ROD M10 - GEWINDESTANGE M10 - TIGE FILETÉE M10  | | 4 | | 2000 |
| PL1 | | FILLE FOR TERRACE RAILING - LEISTE FÜR TERRASSE - BAGUETTE POUR CORPS DE TERRASSE  | | 4 | 18x18 | 2067 |
| PL2 | | FILLE FOR TERRACE RAILING - LEISTE FÜR TERRASSE - BAGUETTE POUR CORPS DE TERRASSE  | | 2 | 18x70 | 2067 |
| PL3 | | FILLE FOR TERRACE RAILING - LEISTE FÜR TERRASSE - BAGUETTE POUR CORPS DE TERRASSE  | | 49 | 28x34 | 994 |
| P | | POST - PFOSTEN - POTEAU  | | 1 | 70x70 | 2067 |
| GL3 | | EAVES BOARD - TRAUFBRETT - BANDEAU DE TOIT  | | 4 | 18x120 | 4506 |
| GL1 | | GABLE MOULDING - GIEBELLEISTE - PLANCHE DE RIVE  | | 4 | 18x120 | 2600 |
| GL2 | | GABLE MOULDING - GIEBELLEISTE - PLANCHE DE RIVE  | | 4 | 18x120 | 3236 |
| | | WINDOW HANDLE FITTINGS-FENSTERGRIFF - POIGNÉE D'OUVERTURE DE FENETRE  | | 2 | | |
| LD1 | | LID FOR TREADED ROD HOLE - ABDECKUNG FÜR GEWINDESTANGENÖFFNUNG - COUVERCLE POUR ACCÈS RÉGLAGÉ TIGE FILETÉE  | | 1 | | |

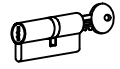
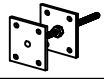
| Pos | 13.03.2017 | Piece list - Stückliste - Liste des pièces Art.Nr. 4413802 | 9/10 | Q. | P (mm) | L (mm) |
|-------|------------|---------------------------------------------------------------------------------------------------------------------------------------------|---------------------------------------------------------------------------------------|-----|-----------|-----------|
| | | LENGTHENING BOLT FOR TREADED ROD - VERLÄNGERUNGSMUTTER FÜR GEWINDESTANGE - MANCHON DE RACCORDÉMENT DE TIGE FILETÉE |  | 5 | | |
| | | DRIVE NUT TREADED ROD - EINSHLAGMUTTER FÜR GEWINDESTANGE - ÉCROU A FRAPPER POUR TIGE FILITÉE |  | 5 | | |
| | | NUT FOR TREADED ROD - MUTTER FÜR GEWINDESTANGE - ÉCROU POUR TIGE FILETÉE |  | 5 | | |
| | | PLAIN WASHER TREADED ROD - UNTERLEGSCHIEBE FÜR GEWINDESTANGE - RONDELLE PLATE POUR TIGE FILETÉE |  | 5 | | |
| HS104 | | SCREW FOR SLIDING WALL TIE - SCHRAUBEN FÜR WAND SCHIEBEREGLER - VIS DE SABOT METALLIQUE POR FIXATION MUR |  | 8 | 3.5x20 | |
| HS1 | | SCREW FOR FIXING TERRACE RAILING - SCHRAUBE FÜR TERRASSE VIS DE FIXATION DE GARDE-CORPS DE TERRASSE |  | 24 | 3x30 | |
| | | SCREW FOR GABLE MOULDING - SCHRAUBEN FÜR GIEBELLEISTE - VIS DE FIXATION POUR PLANCHE DE RIVE |  | 96 | 3.5x50 | |
| | | SCREW FOR DOOR FILLET - SCHRAUBE ZUR BEFESTIGUNG TÜRLEISTE - VIS D'ASSEMBLAGE DU CADRE DE PORTE |  | 5 | 3x30 | |
| HS103 | | SCREW FOR FIXING TERRACE RAILING - SCHRAUBE FÜR TERRASSE VIS DE FIXATION DE GARDE-CORPS DE TERRASSE |  | 4 | 4.5x80 | |
| | | SCREW FOR POST - SCHRAUBEN FÜR PFOSTEN - VIS DE FIXATION DES POTEAUX |  | 2 | 4.5x80 | |
| | | SCREW FOR FIXING TERRACE RAILING - SCHRAUBE FÜR TERRASSE VIS DE FIXATION DE GARDE-CORPS DE TERRASSE |  | 98 | 4x40 | |
| | | SCREW FOR EAVES BOARDS - SCHRAUBEN FÜR TRAUFBRETTER - VIS DE FIXATION POUR BANDEAU DE TOIT |  | 80 | 4x40 | |
| | | SCREW FOR ROOF BEAMS - SCHRAUBEN FÜR DACHBALKEN - VIS POUR PANNE DE TOIT |  | 24 | 5x120 | |
| | | SCREW FOR GABLE - SCHRAUBEN FÜR GIEBEL - VIS POUR FIXATION DES PIGNONS |  | 8 | 5x120 | |
| | | SCREW FOR FUNDAMENT - SCHRAUBEN ZUR BEFESTIGUNG FUNDAMENT - VIS POUR FONDATION |  | 22 | 5x90 | |
| | | SCREW FOR POS. 006-009; 017-019 - SCHRAUBEN FÜR POS. 006-009; 017-019 VIS POUR FIXATION DERNIÈRE RANGÉE MADRIERS (MURS AVANT ET ARRIÈRE) |  | 46 | 6x180 | |
| HS72 | | SCREW FOR SLIDING WALL TIE - SCHRAUBEN FÜR WAND SCHIEBEREGLER - VIS DE SABOT METALLIQUE POR FIXATION MUR |  | 2 | 6x40 | |
| | | SCREW FOR POST HEIGHT ADJUSTMENT - SCHRAUBEN FÜR REGULIERUNGSSCHRAUBE FÜR PFOSTEN - VIS DE FIXATION DE SUPPORT REGLABLE DE POTEAU |  | 8 | 6x50 | |
| | | ZN NAIL FOR TERRACE - ZN NÄGEL FÜR TERRASSENRETTER - POINTE POUR PLANCHER DE TERRASSE |  | 168 | 2.1x50 | |
| | | ZN NAIL FOR FLOOR FILLET - ZN NÄGEL FÜR FUSSBODENLEISTE - POINTE POUR CORNIÈRE DE FINITION DU PLANCHER |  | 44 | 1.4x40 | |
| | | HAMMER BLOCK - SCHLAGHOLZ - CALLE DE FRAPPE |  | 1 | | |
| | | SCREW FOR DOORSTEP - SCHRAUBEN FÜR TÜRSCHWELLE - VIS DE FIXATION DU SEUIL DE PORTE |  | 3 | 4.5x65 | |
| | | ZN NAIL FOR ROOFING FELT FILLET - ZN NÄGEL FÜR DACHPAPPENLEISTE - POINTE POUR BAGUETTE FIXATION FEUTRE BITUMEUX |  | 34 | 2x40 | |
| SB | | PLAIN WASHER - UNTERLEGSCHIEBE - RONDELLE PLATE |  | 2 | | |
| SL | | SLIDING WALL TIE - SCHIEBEREGLER FÜR WAND - SABOT MÉTALLIQUE POUR FIXATION MUR |  | 2 | | |

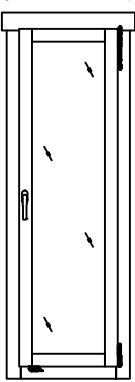
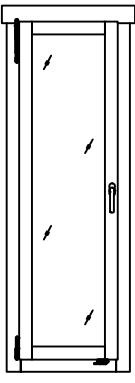
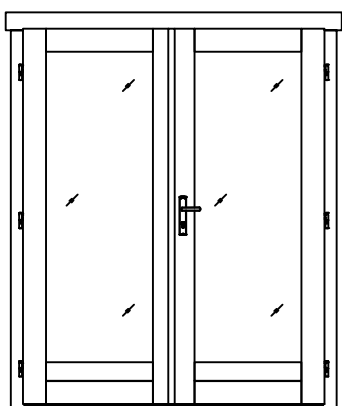
| Pos | 13.03.2017 | Piece list - Stückliste - Liste des pièces Art.Nr. 4413802 | 10/10 | Q. | P (mm) | L (mm) |
|-----|------------|-------------------------------------------------------------------------------------------|-------------------------------------------------------------------------------------|-----|-----------|-----------|
| | | ZN NAIL FOR ROOF - ZN NÄGEL FÜR DACHBRETTER - POINTE POUR TOIT |  | 645 | | |
| | | ZN NAIL FOR FLOOR - ZN NÄGEL FÜR FUSSBODENBRETTER - CLOUS POUR PLANCHER |  | 450 | 2x50 | |
| | | DOOR HANDLE FITTINGS-TÜRGRIF - SET DE GARNITURES DE SERRURE DE PORTE |  | 1 | 2x50 | |
| | | SET OF DOOR LOCK COVERS - SCHLOSSBLENDEN - SET DE GARNITURES DE SERRURE DE PORTE |  | 1 | | |
| | | MALE BOLT HINGE FOR DOOR - TÜRRIEGEL - PARTIE MALE DE CHARNIERE DE PORTE |  | 6 | | |
| | | CYLINDER LOCK -ZYLINDERSCHLOSS - CYLINDRE DE SERRURE |  | 1 | | |
| | | POST HEIGHT ADJUSTMENT - REGULIERUNGSSCHRAUBE FÜR PFOSTEN - SUPPORT RÉGLABLE DE POTEAU |  | 1 | 30x35 | |
| HC | | COVERS FOR DOOR HINGES - SCHUTZKAPPE FÜR TÜRBAND - COUVERTURE DE PAUMELLE DE PORTE |  | 12 | | |
| | | STRIKER FOR BARREL BOLT - HÜLSE FÜR GRENDDELRIEGEL - GACHE AU SOL DU TARGETTE |  | 2 | | |
| | | WINDOW - FENSTER - FENETRE 560x1780 AK.1.100.PSP | DGP+ | 1 | | |
| | |  | | | | |
| | | WINDOW - FENSTER - FENETRE 560x1780 AK.1.100.PSV | DGP+ | 1 | | |
| | |  | | | | |
| | | DOOR - TÜR - PORTE 1588x1957 TUK.1.100.PVP.MM | DGP+ | 1 | | |
| | |  | | | | |